

SOMA-Würfel

Einführung

Der SOMA-Würfel besteht aus sieben Somasteinen:

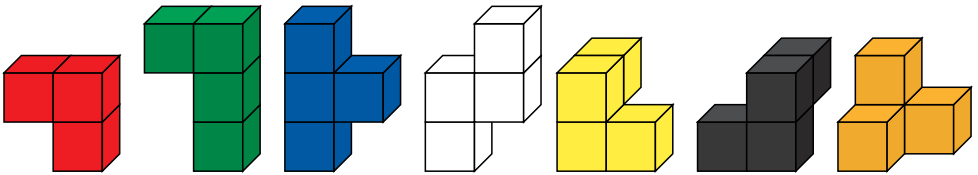

Das Grundproblem des SOMA-Würfels ist es, aus den sieben Einzelteilen einen Würfel zusammenzusetzen:

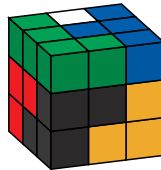

Es gibt 240 Lösungen für dieses Problem. Eine dieser Lösungen ist auf der Karte 23 abgebildet.

Aus den SOMA-Würfelteilen kann man aber auch viele andere Figuren bauen:

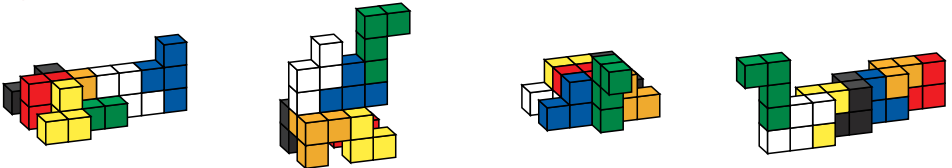

Hinweis

Bei den Aufgabenkarten sind auf der Rückseite die Lösungen abgedruckt. Versuche aber zuerst die Aufgabe alleine zu lösen.



Somafiguren

Aufgabe: Baue das Kanu aus zwei Somateilen.

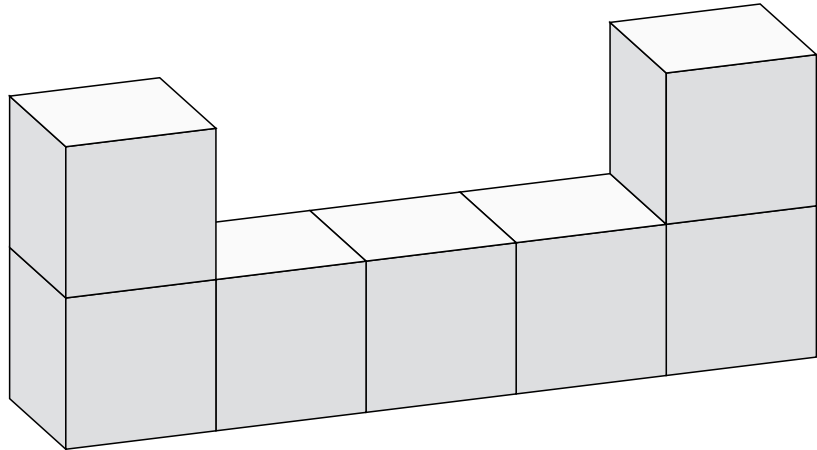

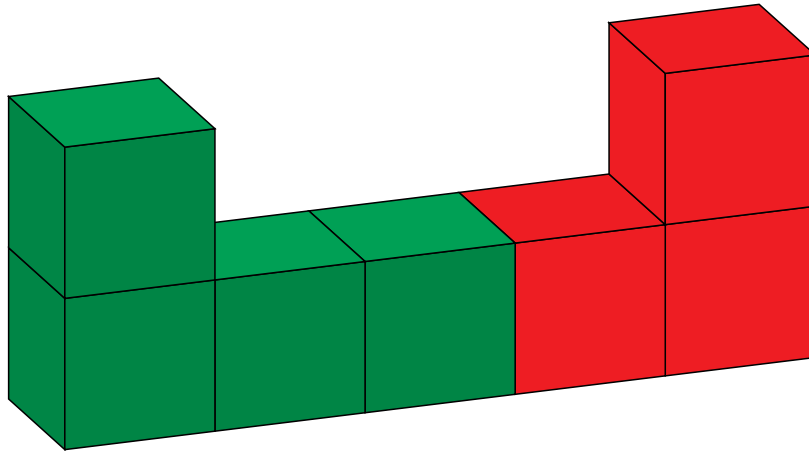



Somafiguren

Aufgabe: Baue den Hund aus zwei Somateilen.

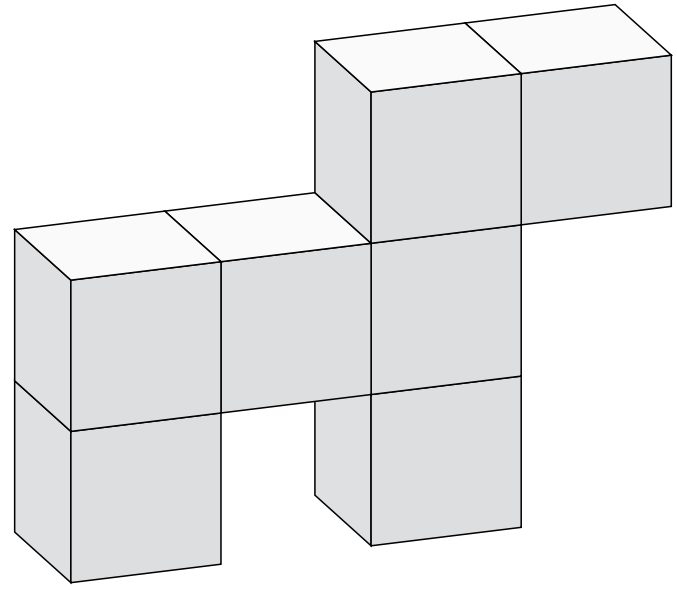

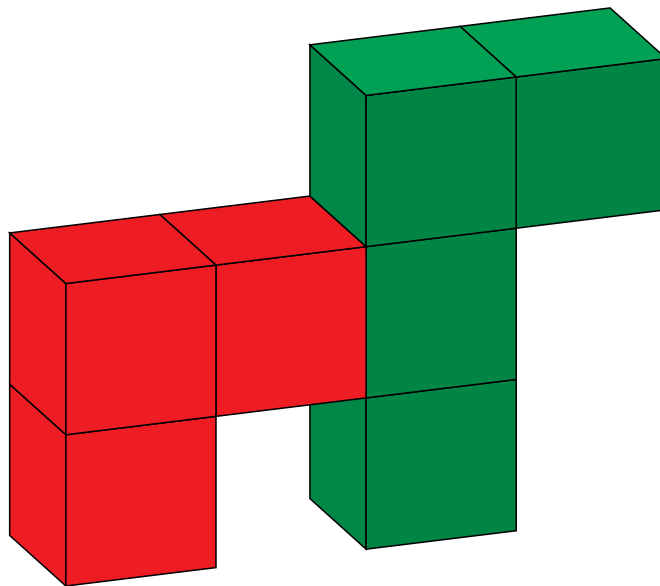



Somafiguren

Aufgabe: Baue das Mauselloch aus zwei Somateilen.

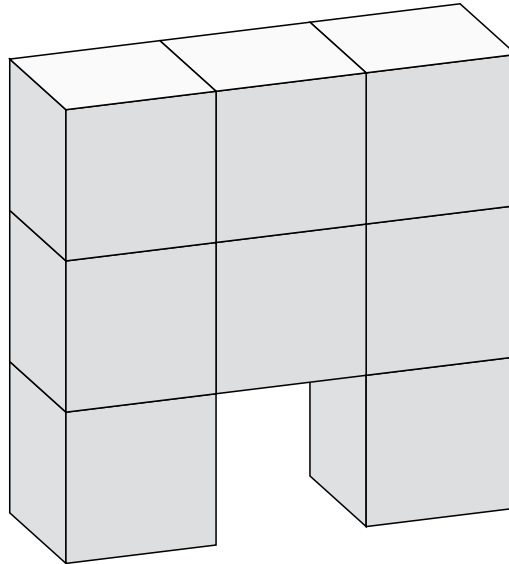

Mauselloch



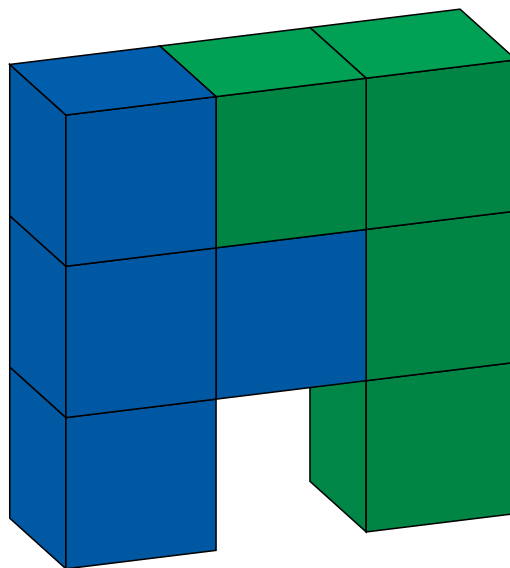

Somafiguren

Aufgabe: Baue den Stuhl aus zwei Somateilen.

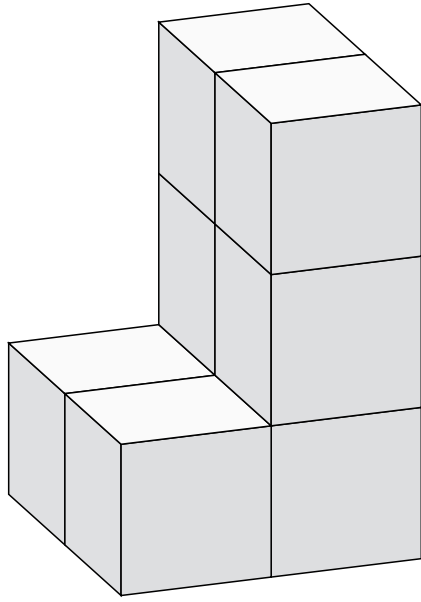

Stuhl



Eine mögliche Lösung

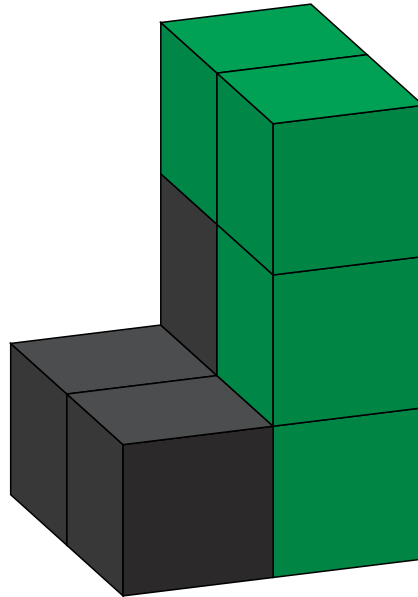



Somafiguren

Aufgabe: Baue den Topfdeckel aus drei Somateilen.

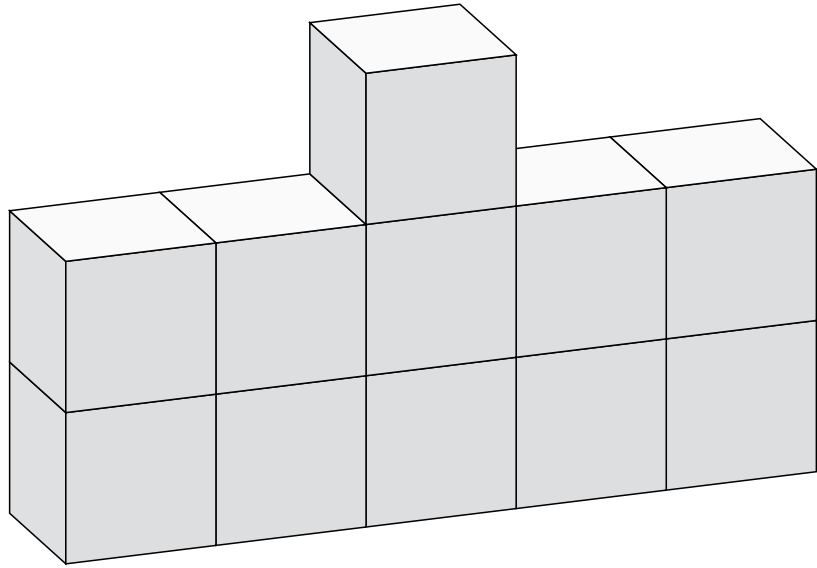

Topfdeckel



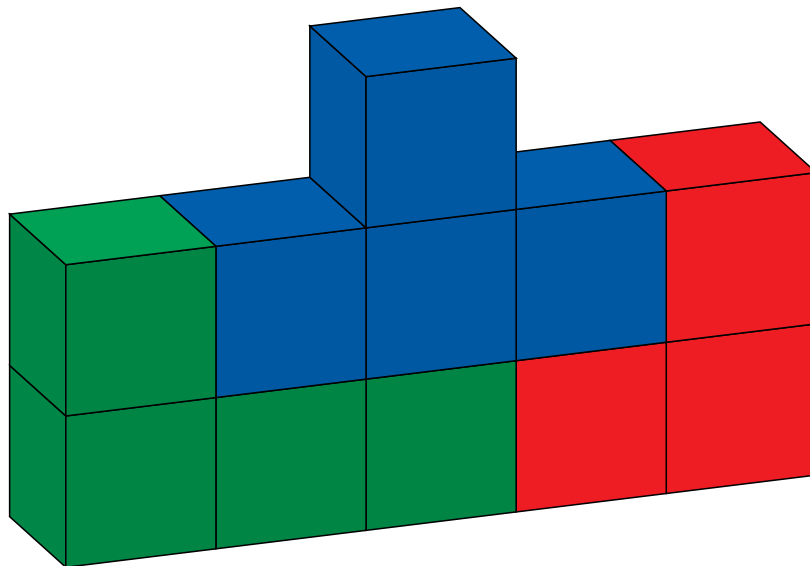

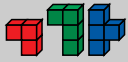

Somafiguren

Aufgabe: Baue das Schlüsselloch aus drei Somateilen.

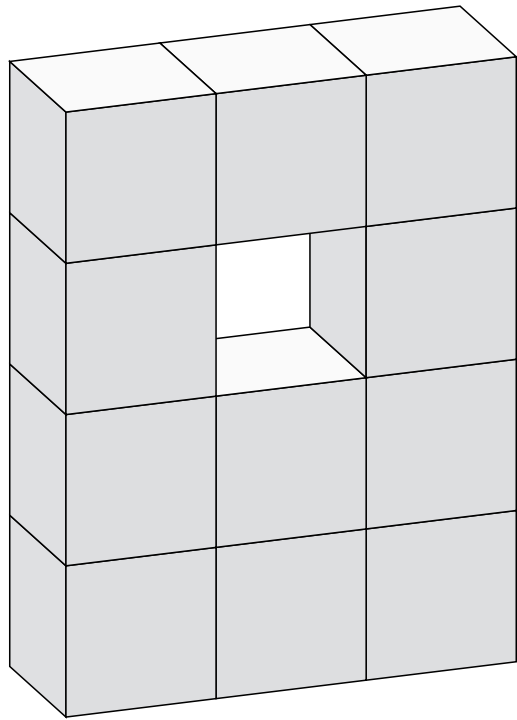

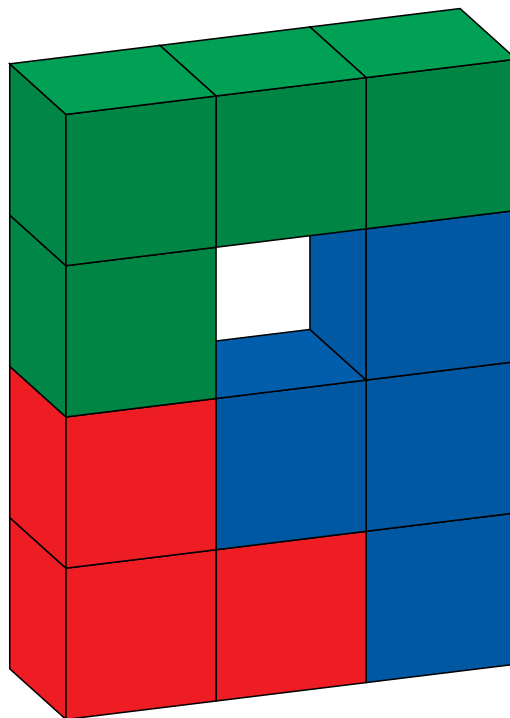

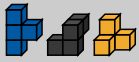

Somafiguren

Aufgabe: Baue die Box aus drei Somateilen.

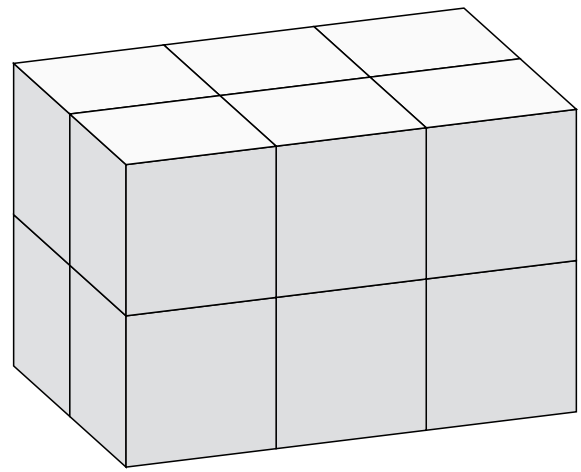

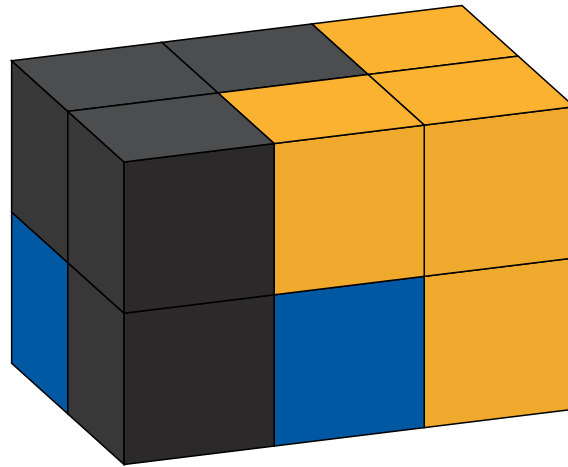



Somafiguren

Aufgabe: Baue die Parkbank aus drei Somateilen.

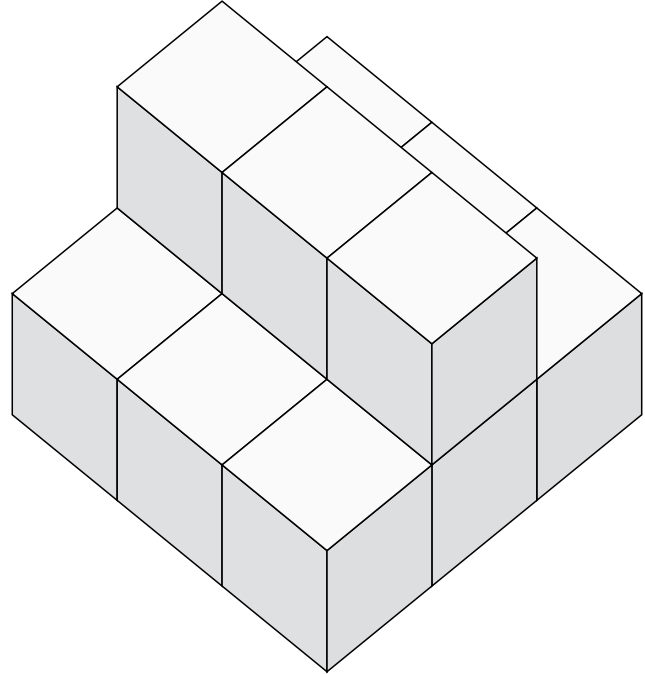

Parkbank



Eine mögliche Lösung

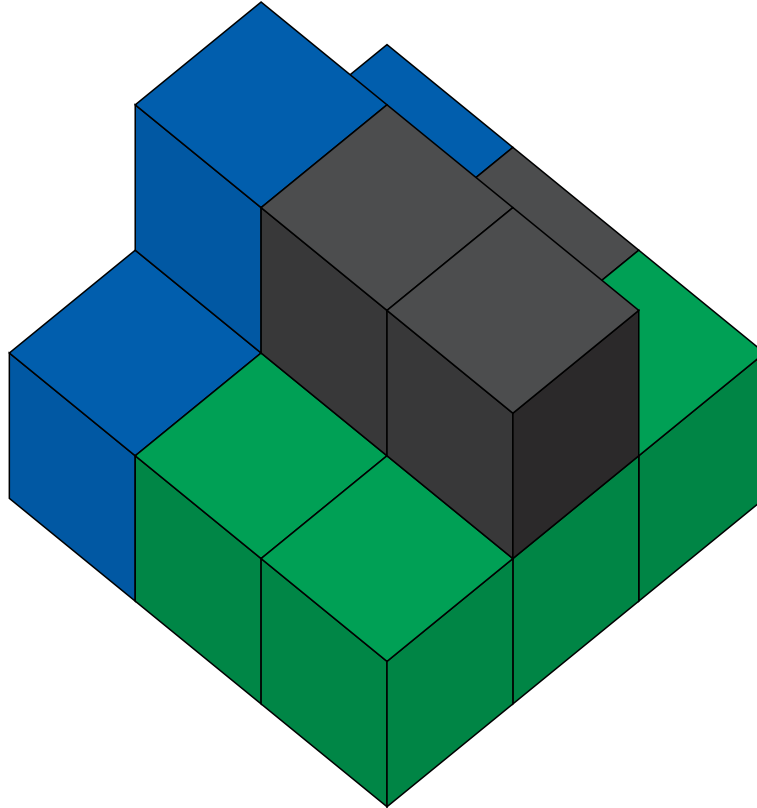



Somafiguren

Aufgabe: Baue die Treppe aus vier Somateilen.

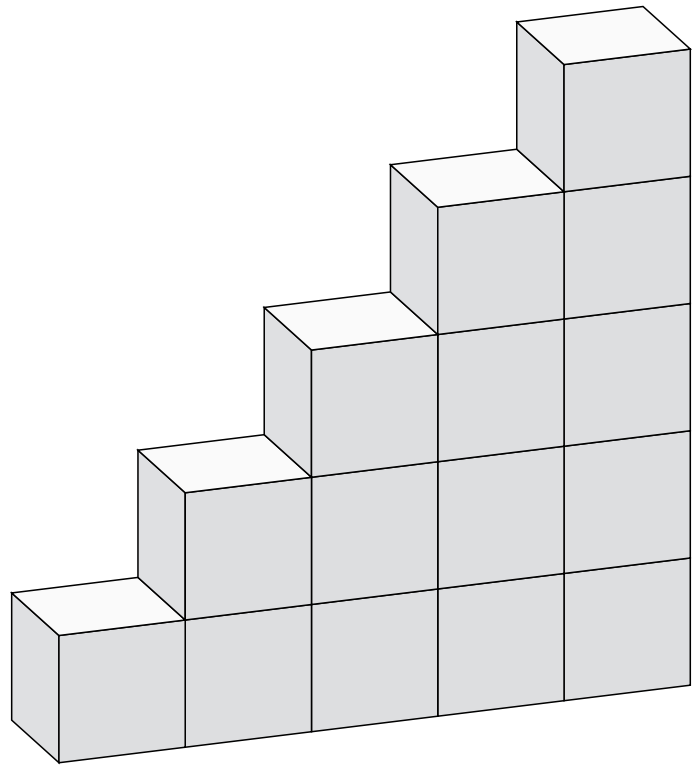

Stufen



Eine mögliche Lösung

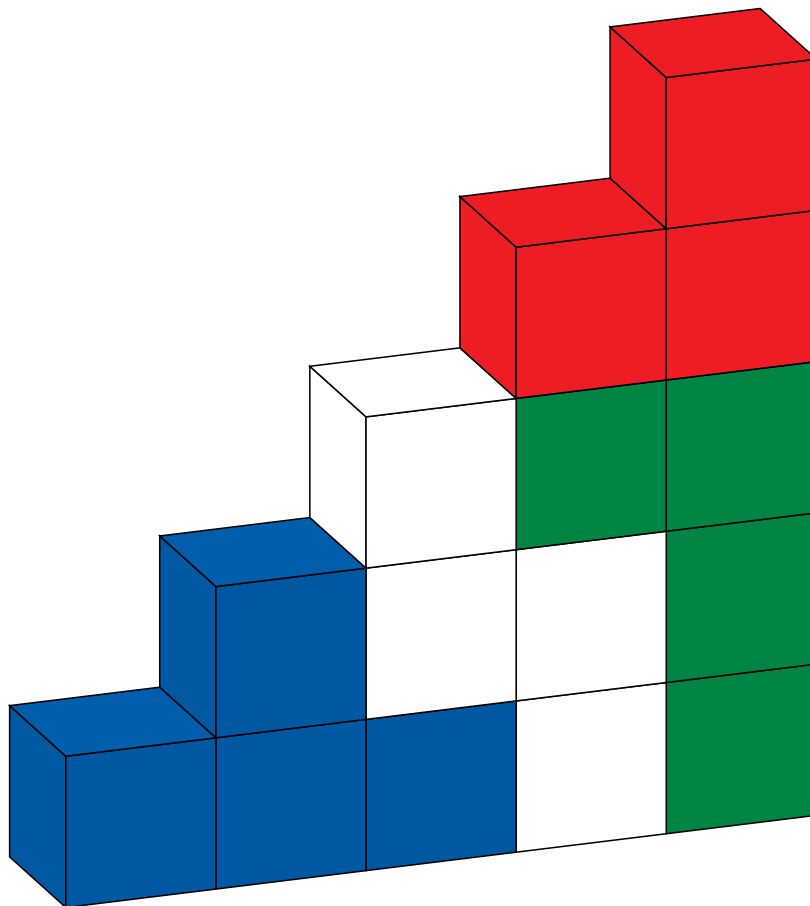



Somafiguren

Aufgabe: Baue die Ecke aus vier Somateilen.

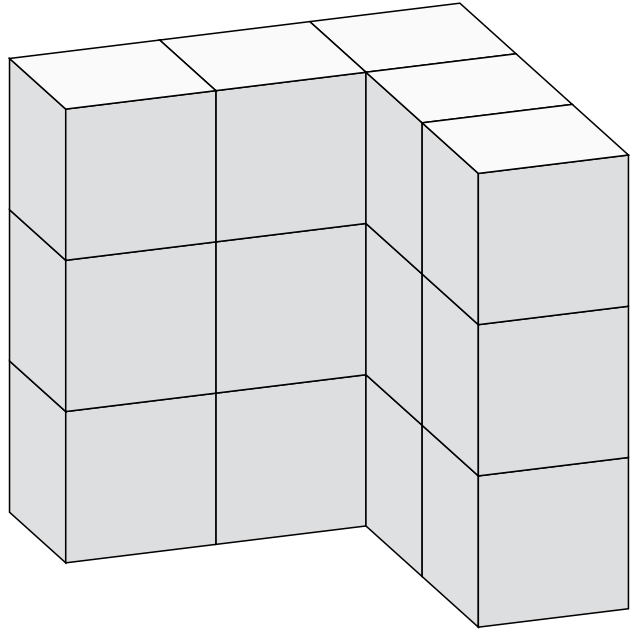

Ecke



Eine mögliche Lösung

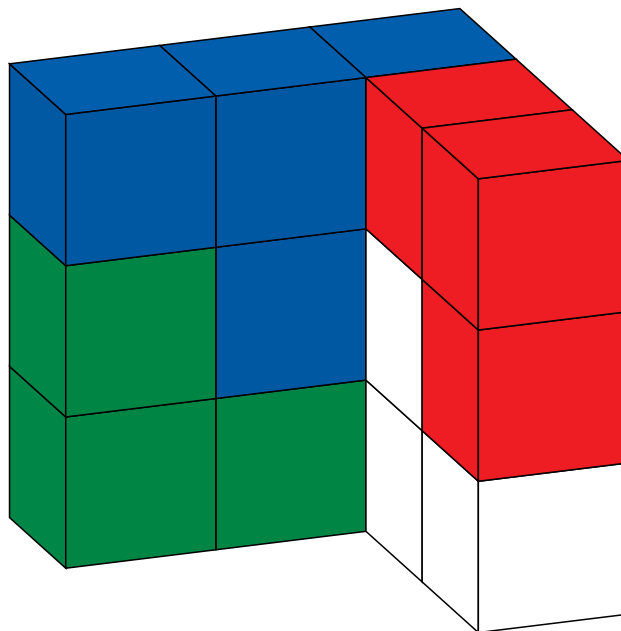

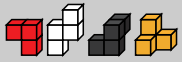

Somafiguren

Aufgabe: Baue das Bett aus vier Somateilen.

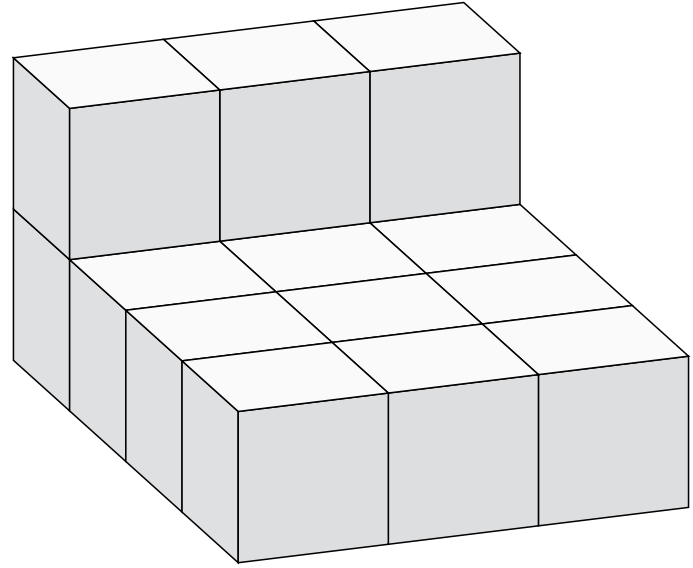

Bett



Eine mögliche Lösung

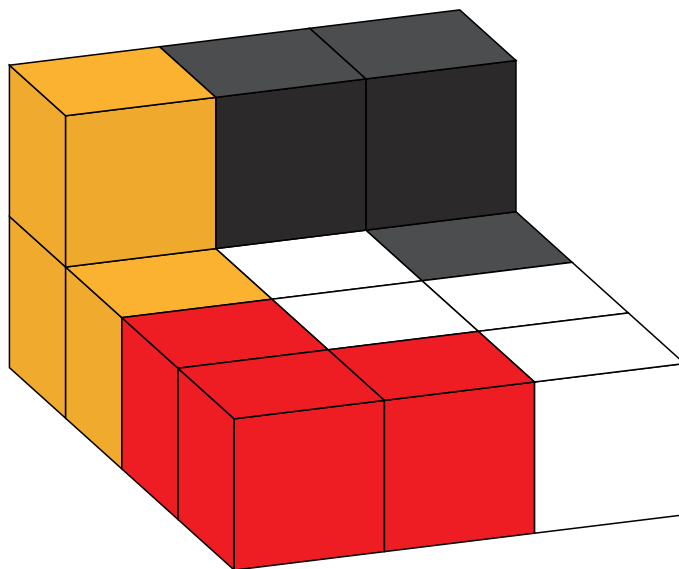



Somafiguren

Aufgabe: Baue die Wand aus vier Somateilen.

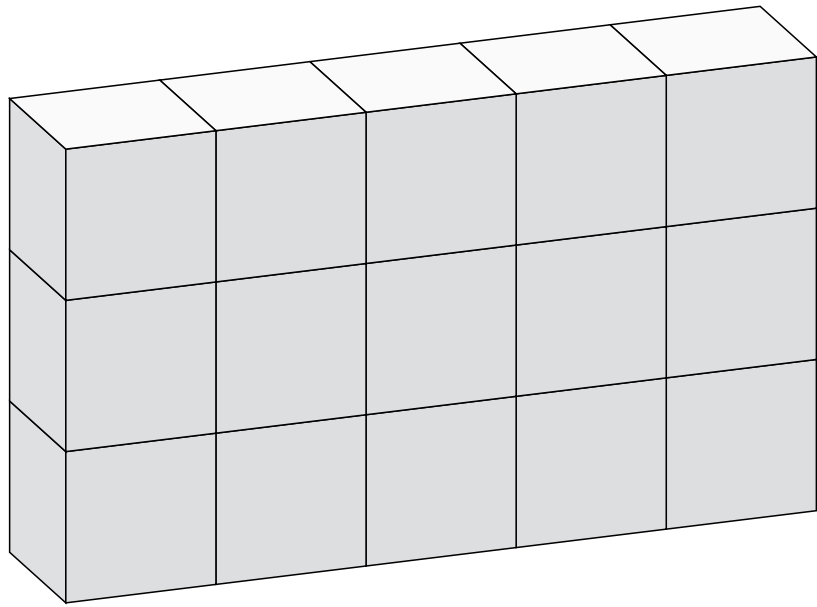

Wand



Eine mögliche Lösung

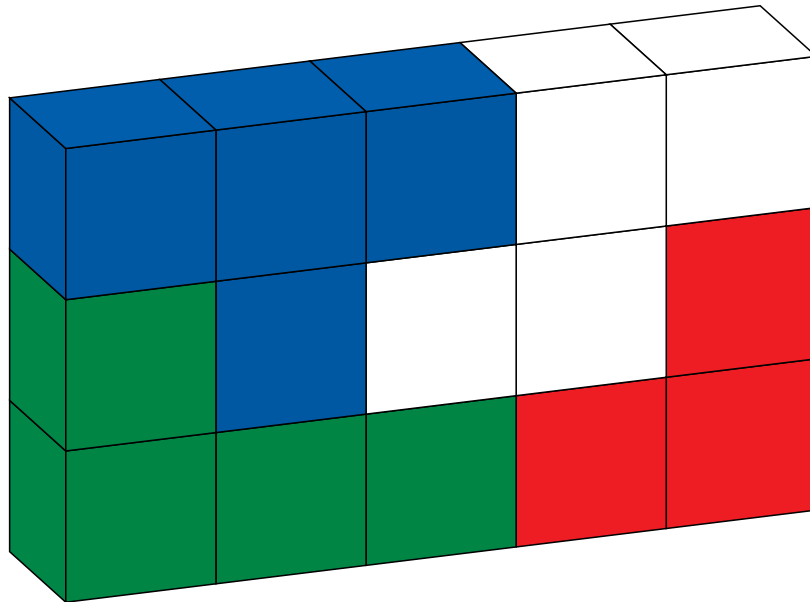

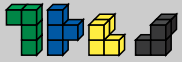

Somafiguren

Aufgabe: Baue den Buchstaben H aus vier Somateilen.

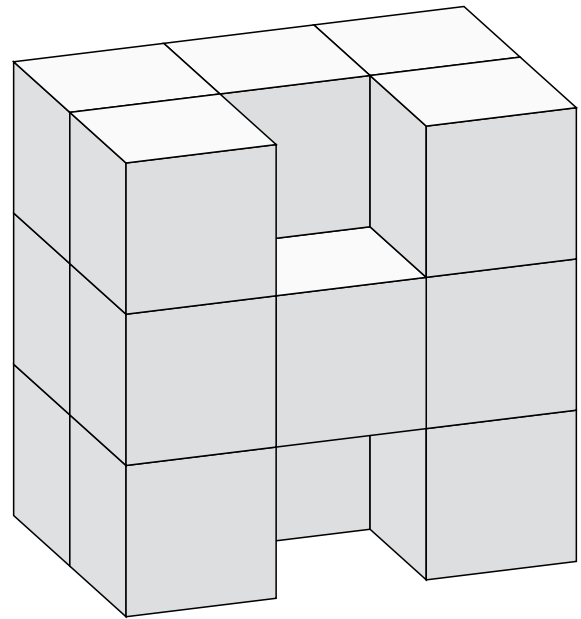

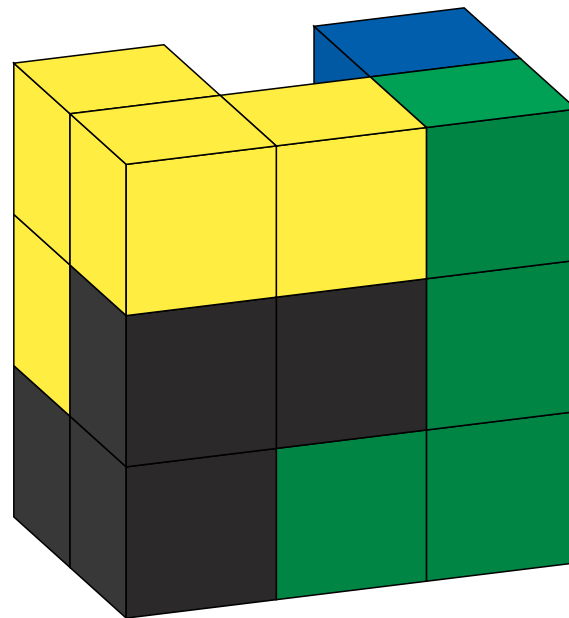
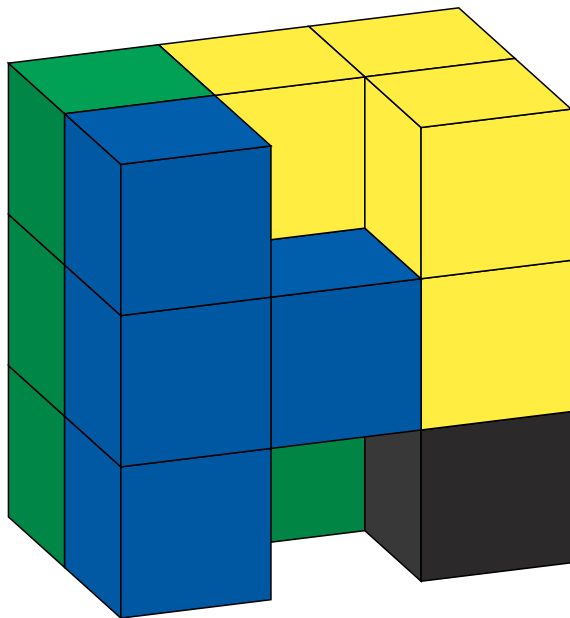



Somafiguren

Aufgabe: Baue die Kellertreppe aus vier Somateilen.

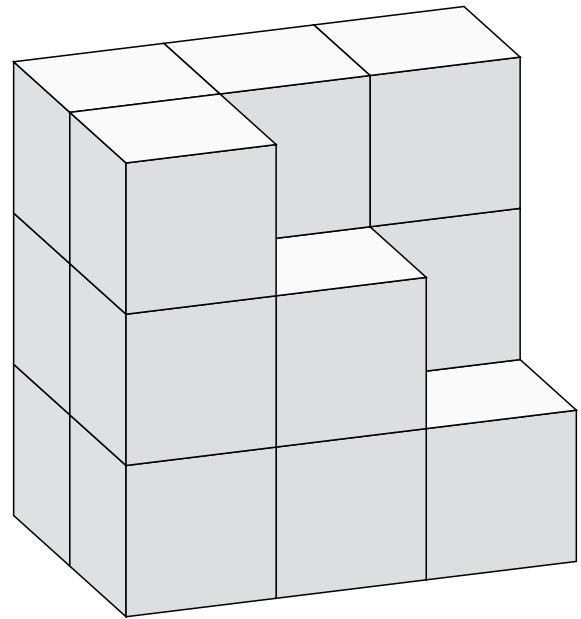

Kellertreppe



Eine mögliche Lösung

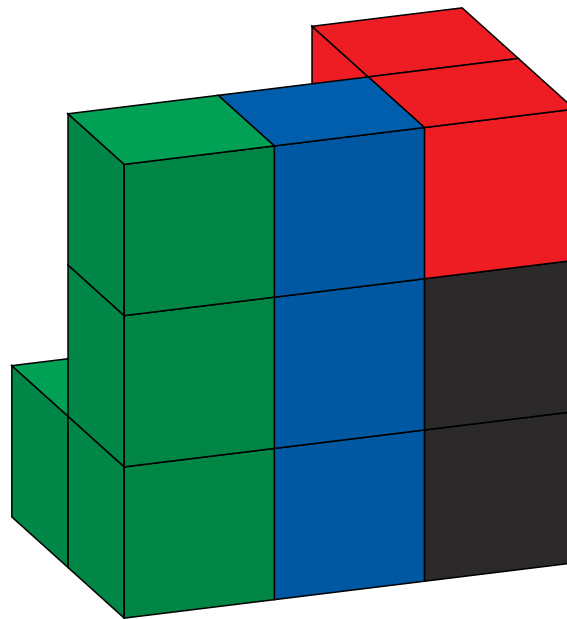
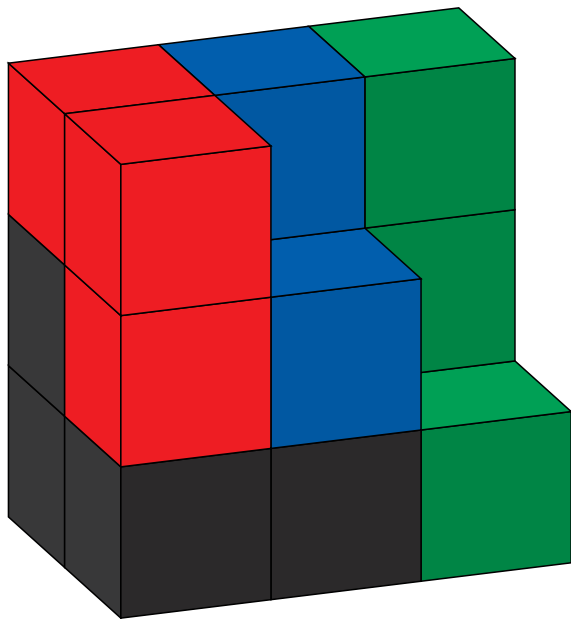

Somafiguren

15

Aufgabe: Baue den Schwan aus allen sieben Somateilen.

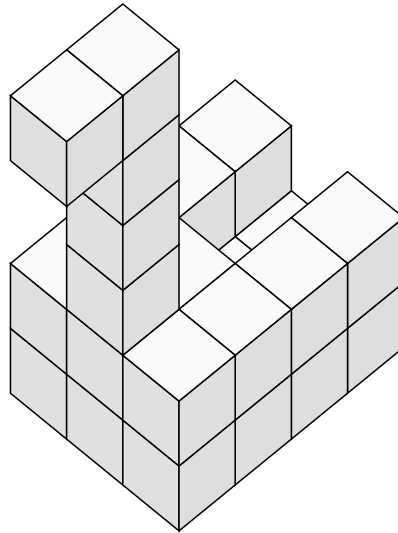

Schwan



Eine mögliche Lösung

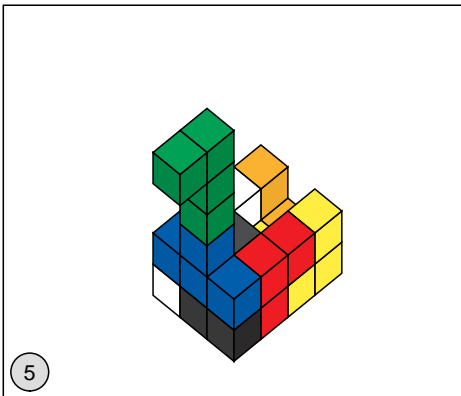
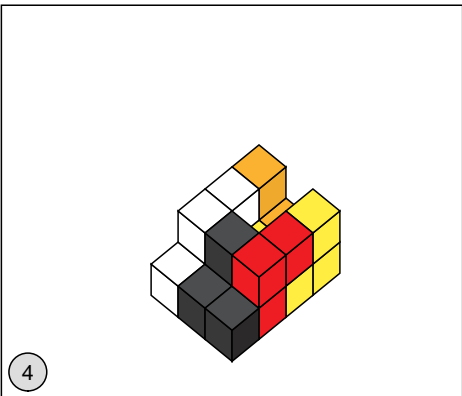
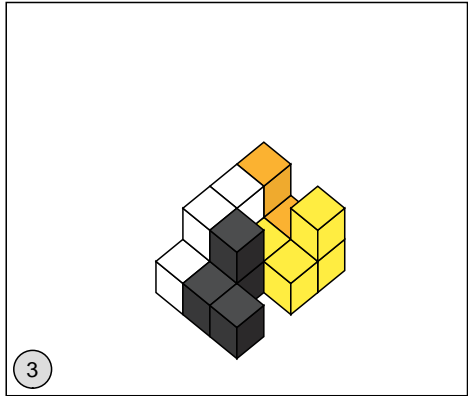
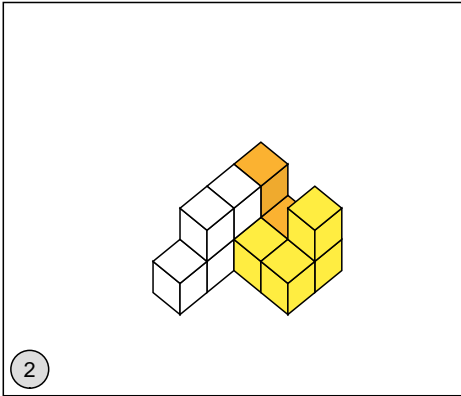
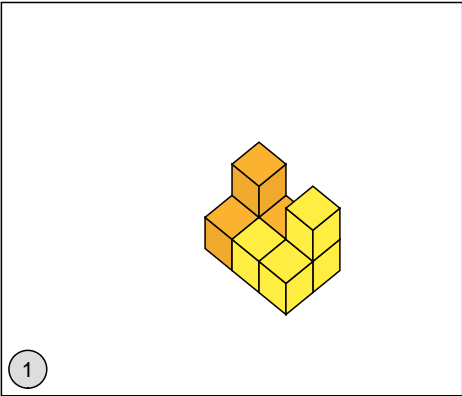

Somafiguren

16

Aufgabe: Baue die Ente aus allen sieben Somateilen.

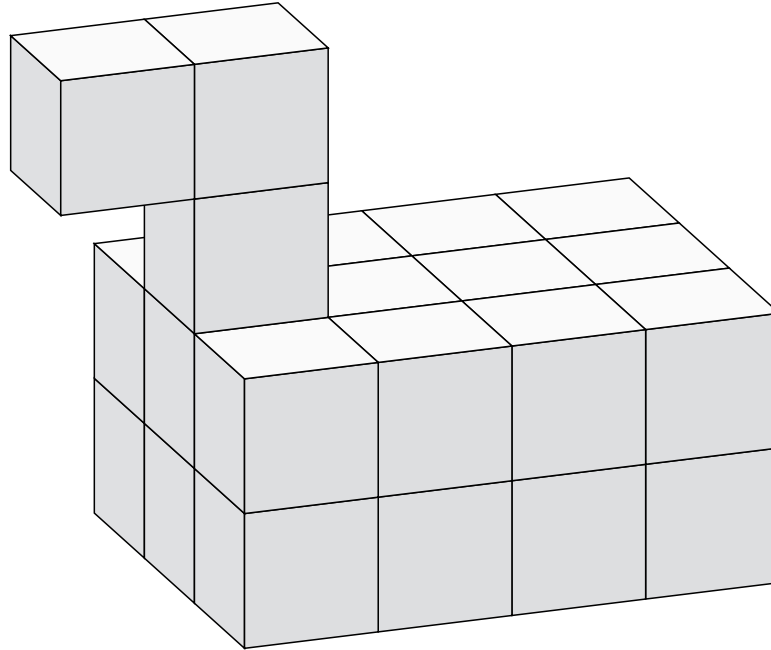

Ente



Eine mögliche Lösung

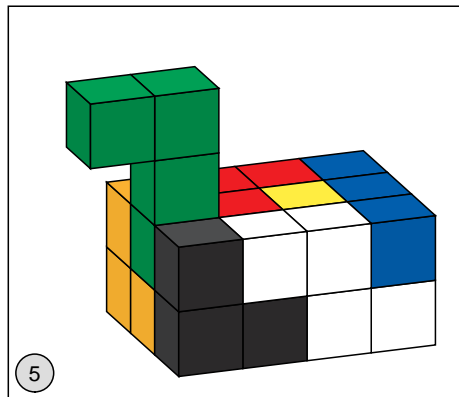
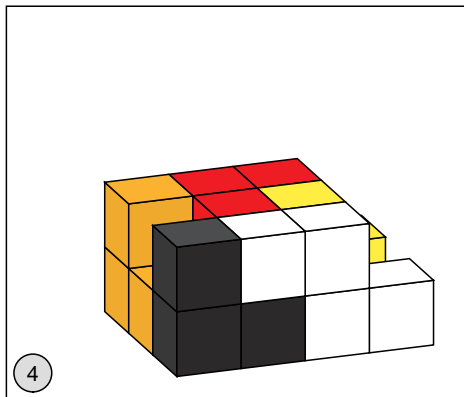
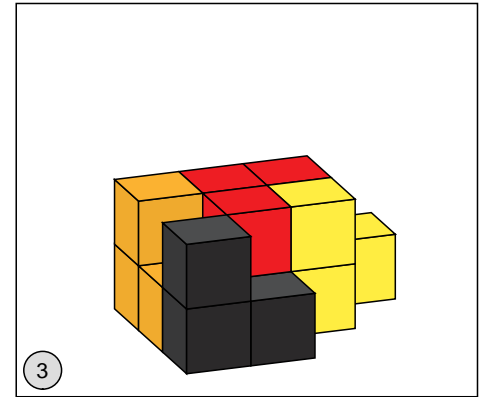
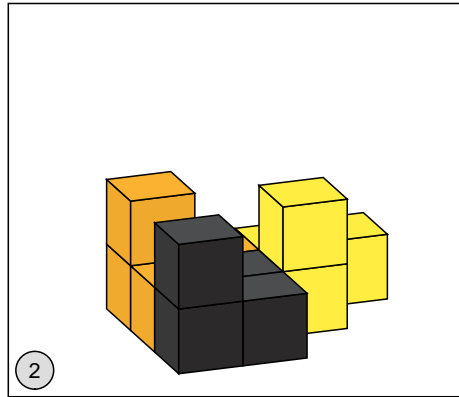
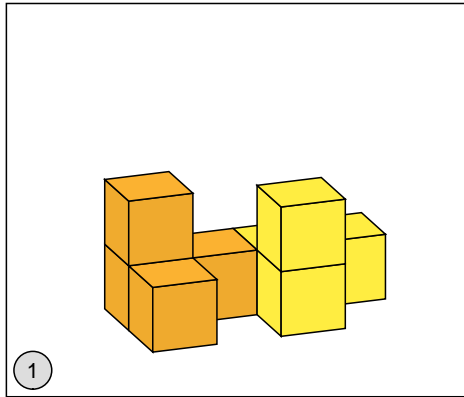

Somafiguren

17

Aufgabe: Baue den Thron aus allen sieben Somateilen.

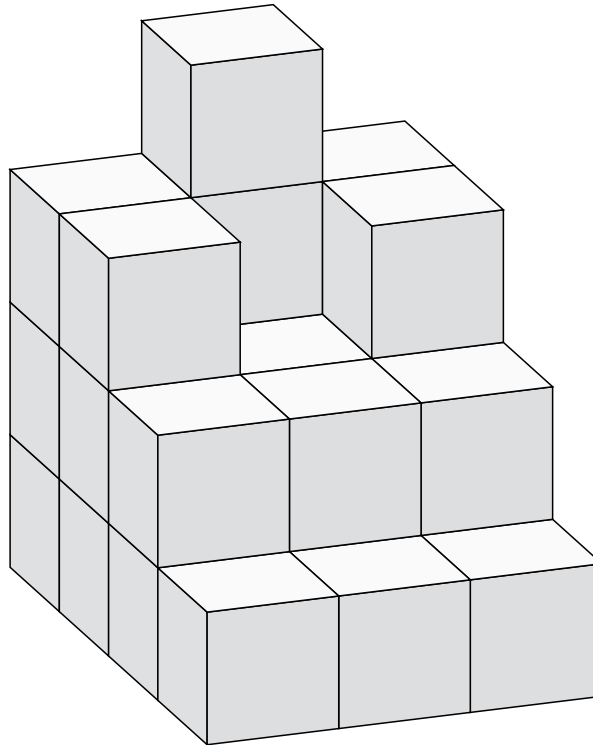

Thron



Eine mögliche Lösung

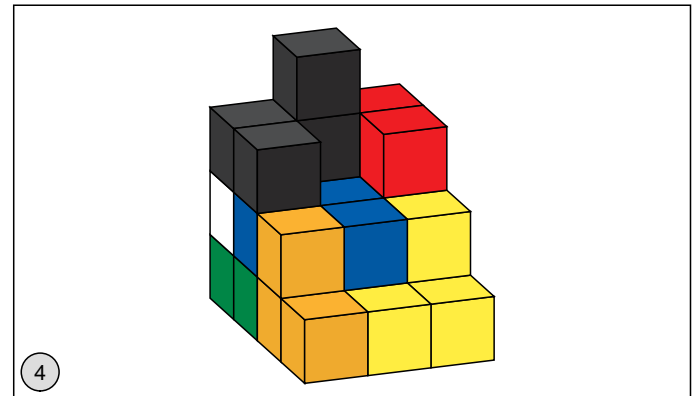
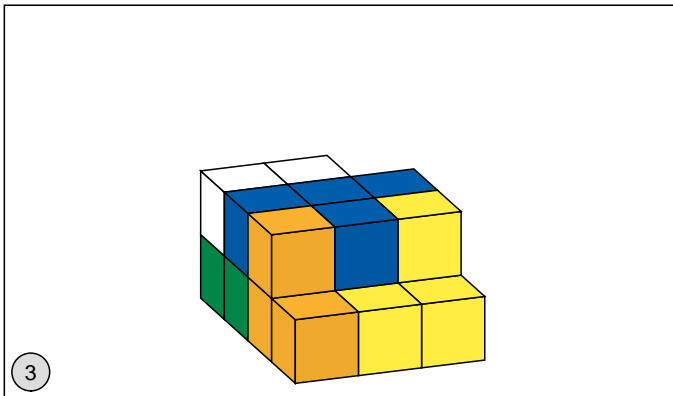
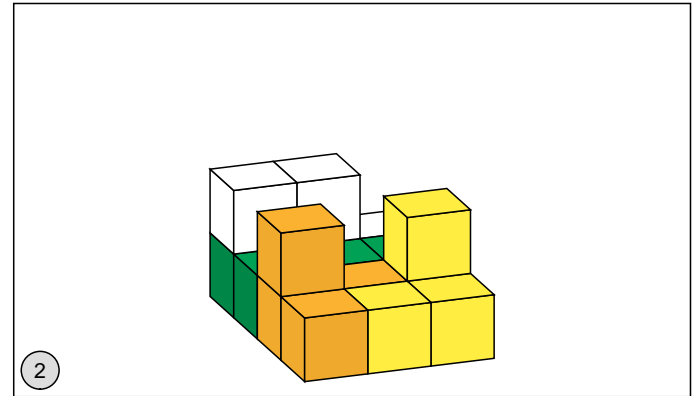
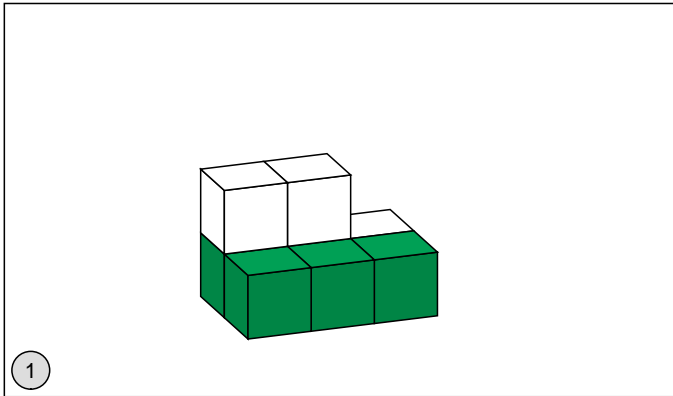

Somafiguren

18

Aufgabe: Baue das kleine Bett aus allen sieben Somateilen.

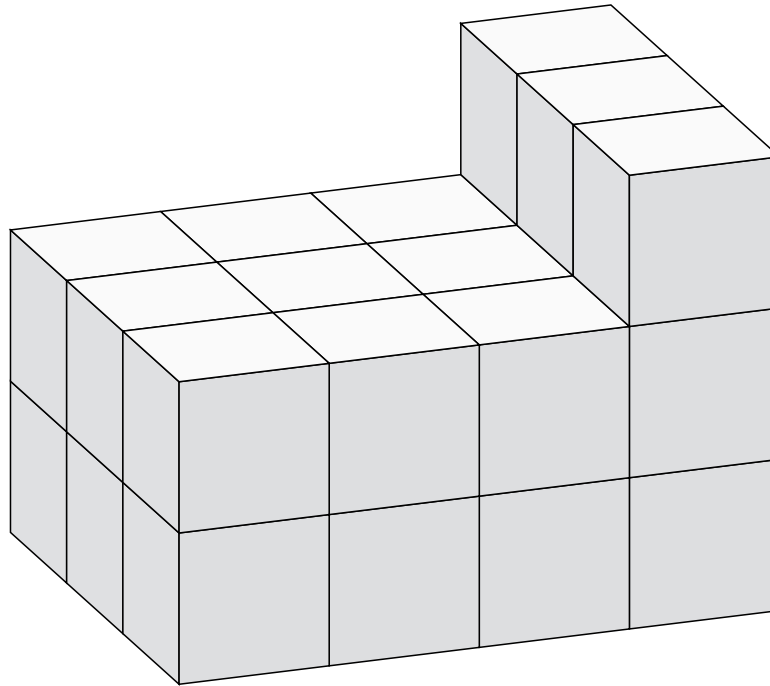

Kleines Bett



Eine mögliche Lösung

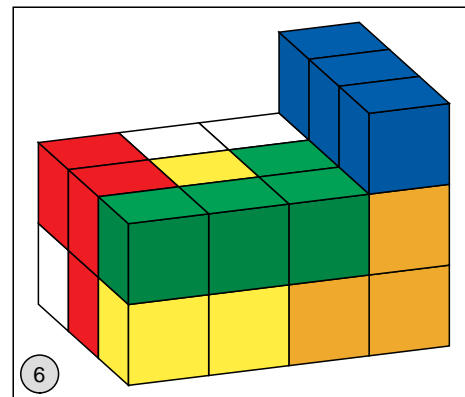
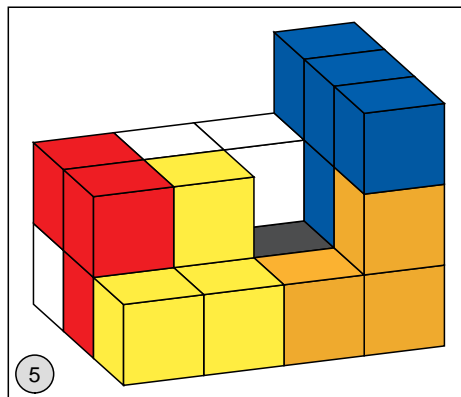
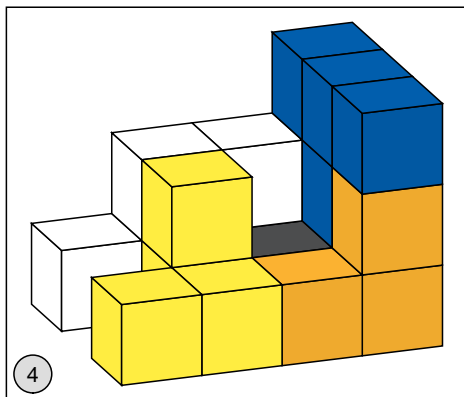
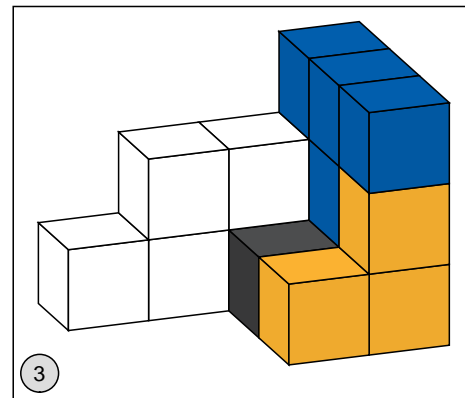
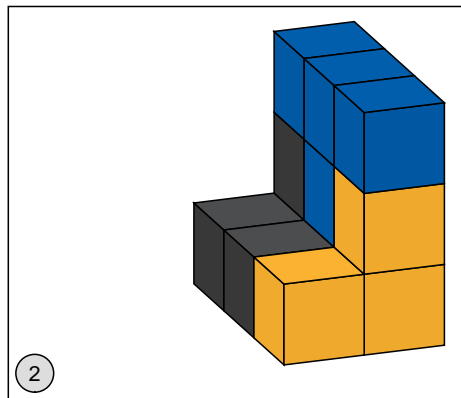
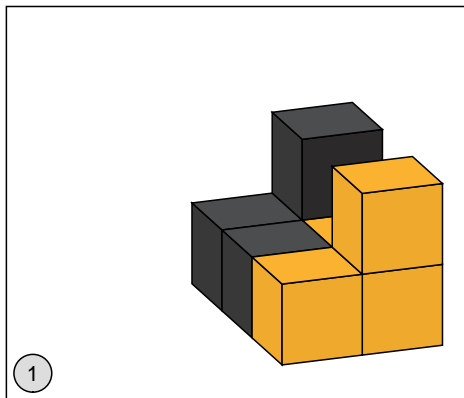

Somafiguren

19

Aufgabe: Baue die Treppe aus allen sieben Somateilen.

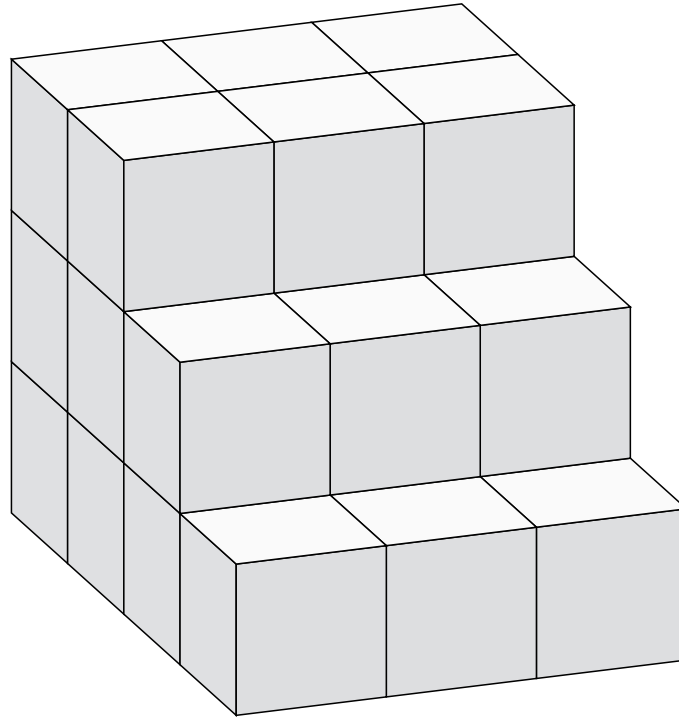

Treppe



Eine mögliche Lösung

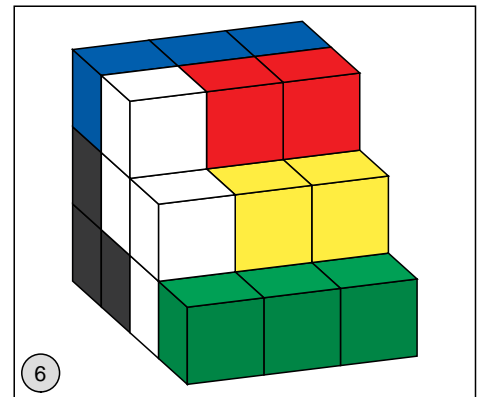
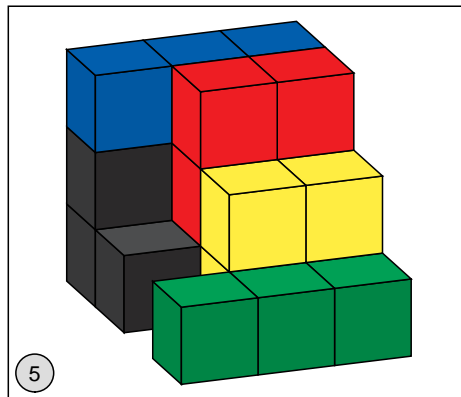
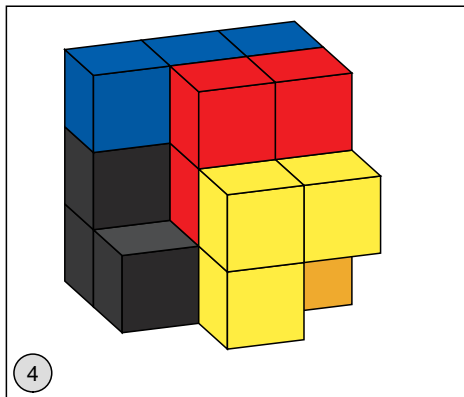
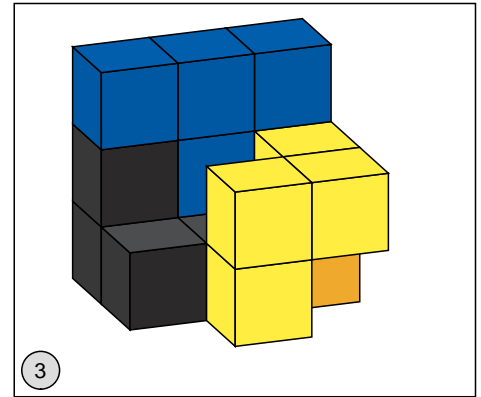
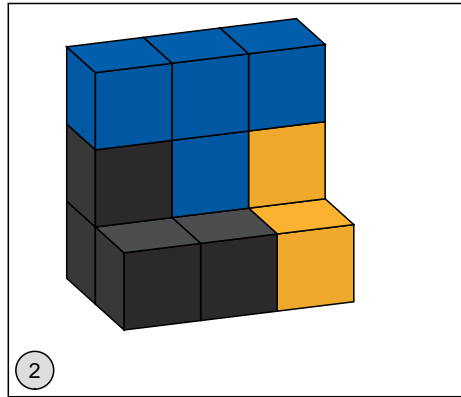
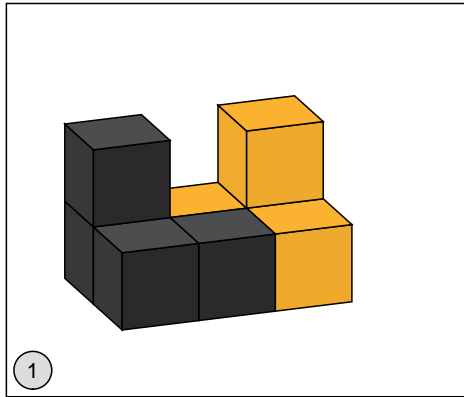

Somafiguren

20

Aufgabe: Baue die Schnecke aus allen sieben Somateilen.

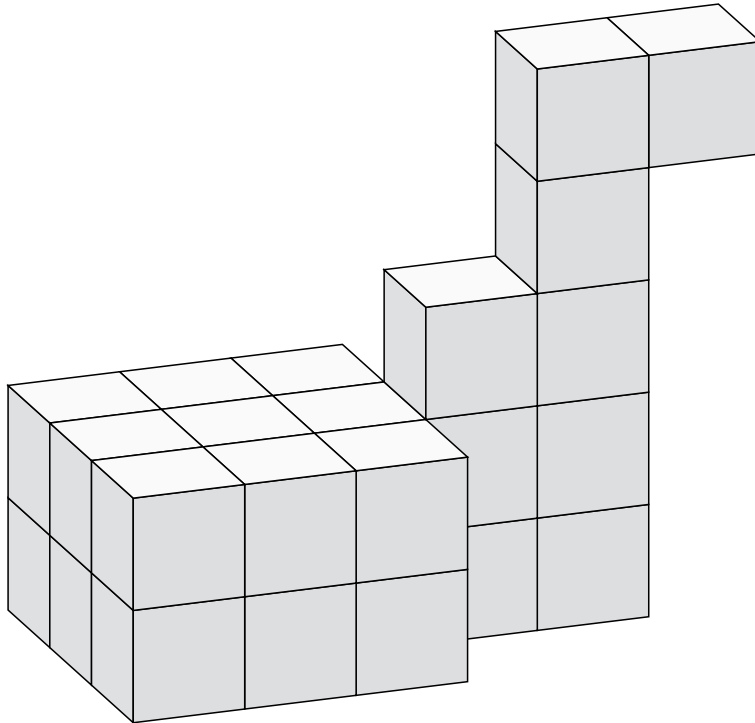

Schnecke



Eine mögliche Lösung

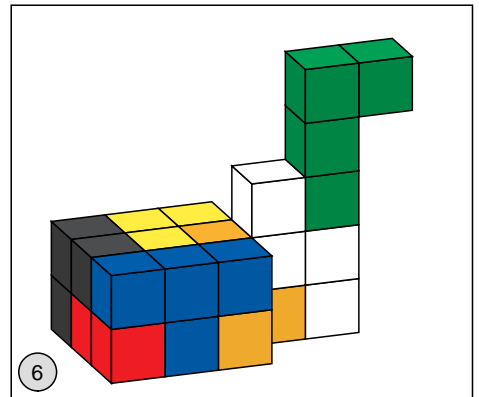
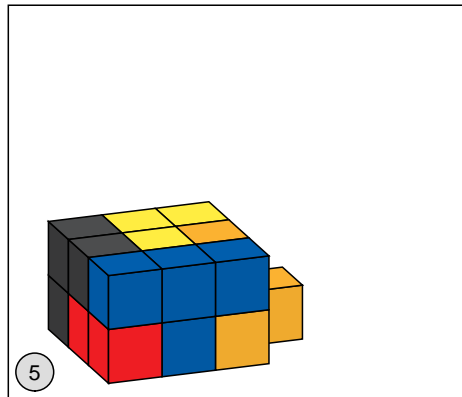
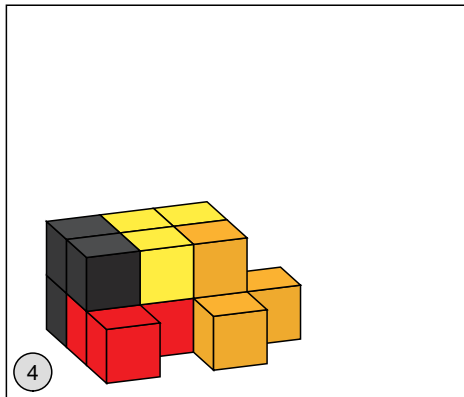
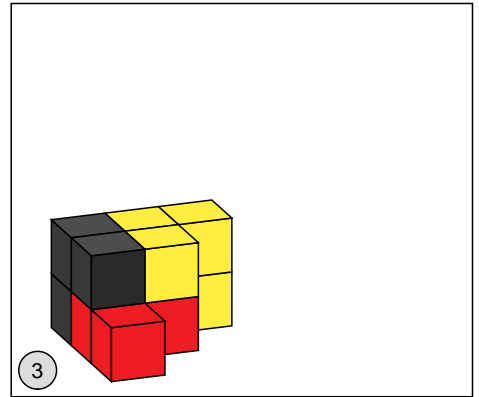
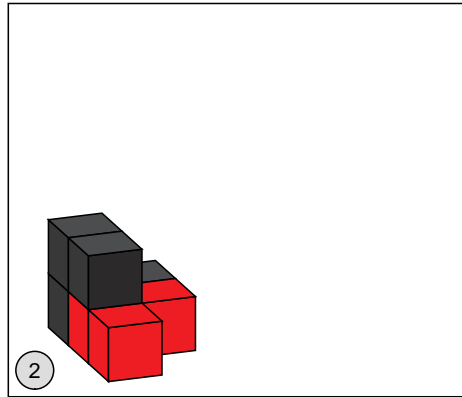
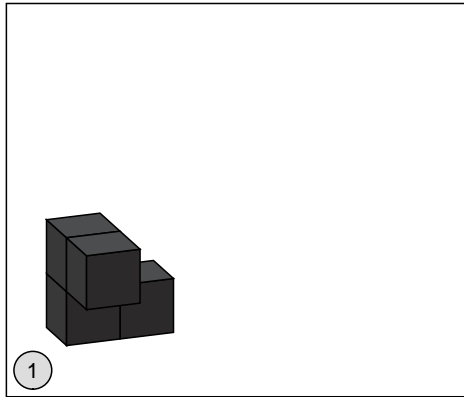

Somafiguren

21

Aufgabe: Baue die Wanne aus allen sieben Somateilen.

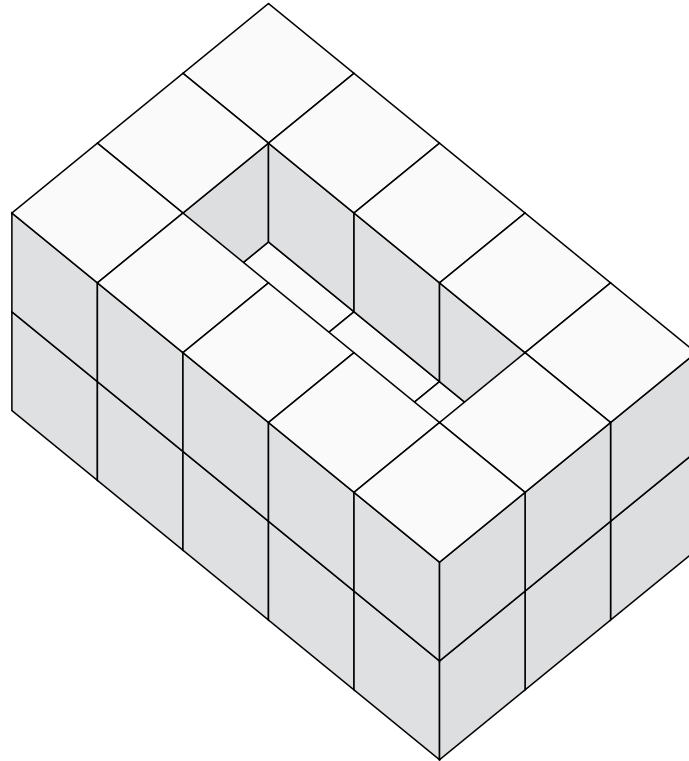

Wanne



Eine mögliche Lösung

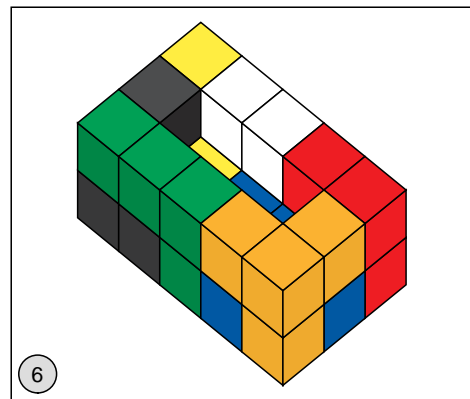
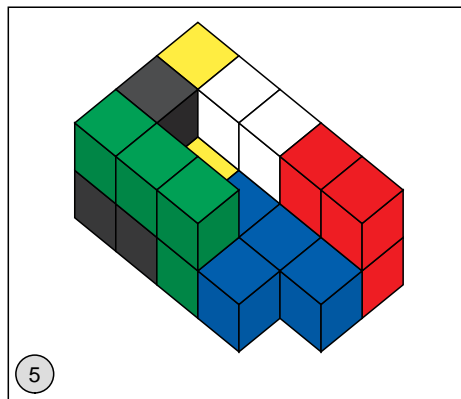
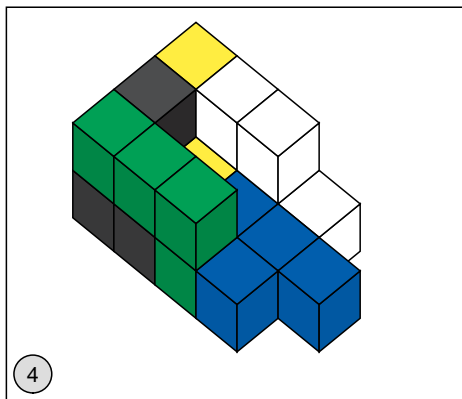
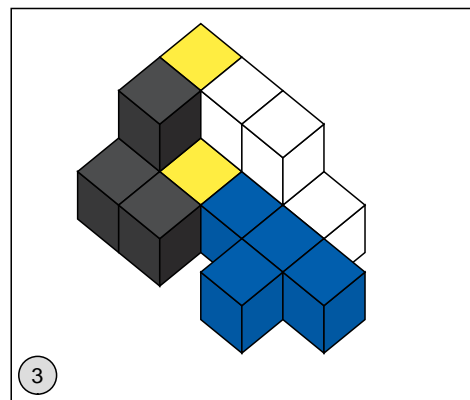
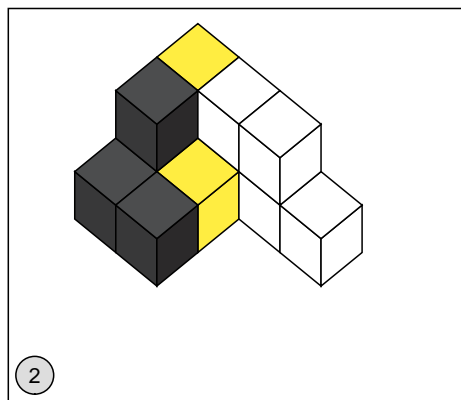
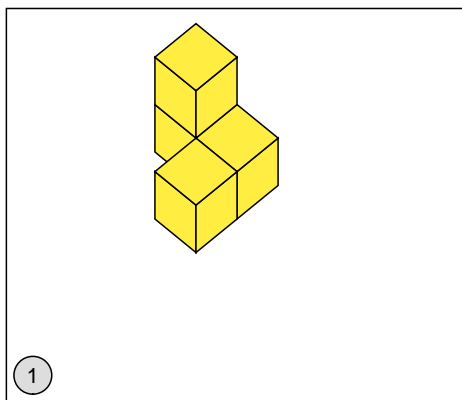

Somafiguren

22

Aufgabe: Baue den Stuhl aus allen sieben Somateilen.

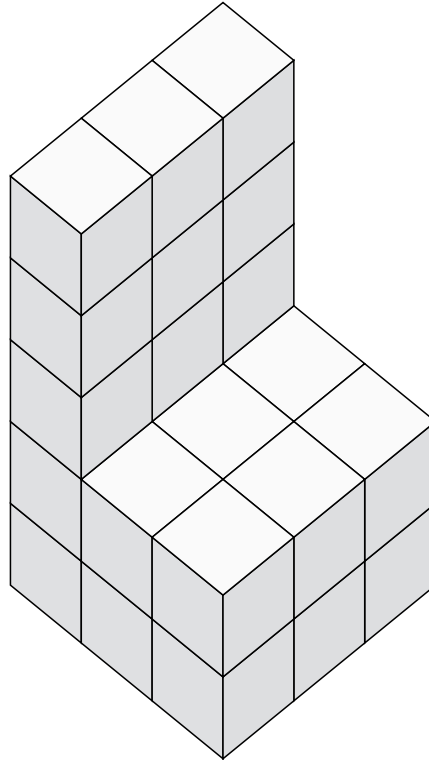

Stuhl



Eine mögliche Lösung

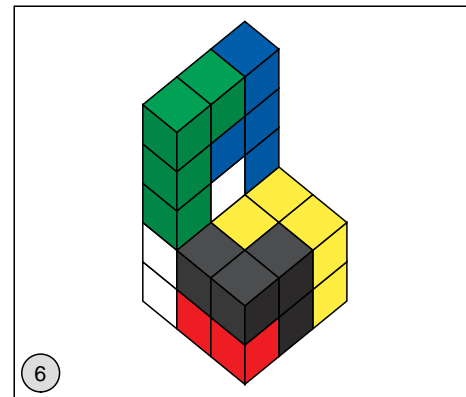
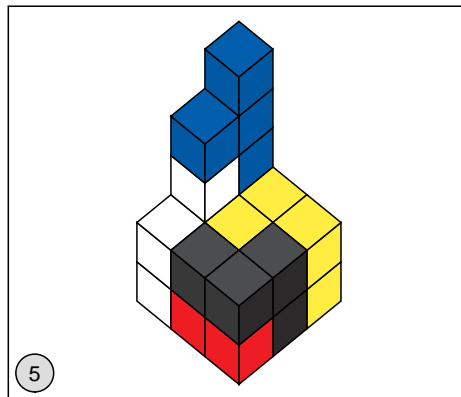
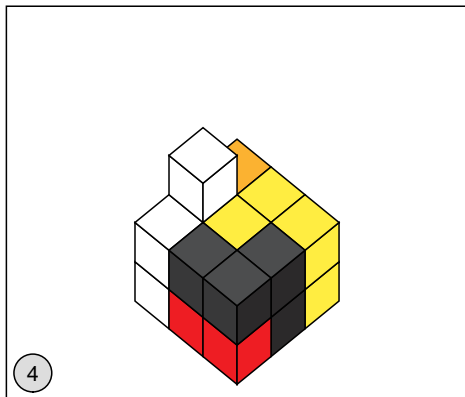
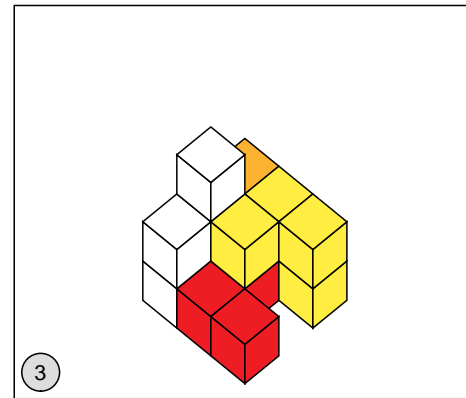
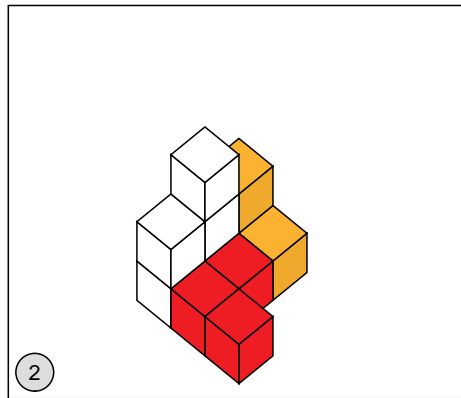
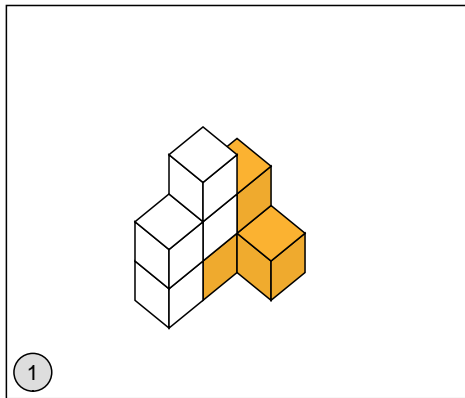

Somafiguren

23

Aufgabe: Baue den Tunnel aus allen sieben Somateilen.

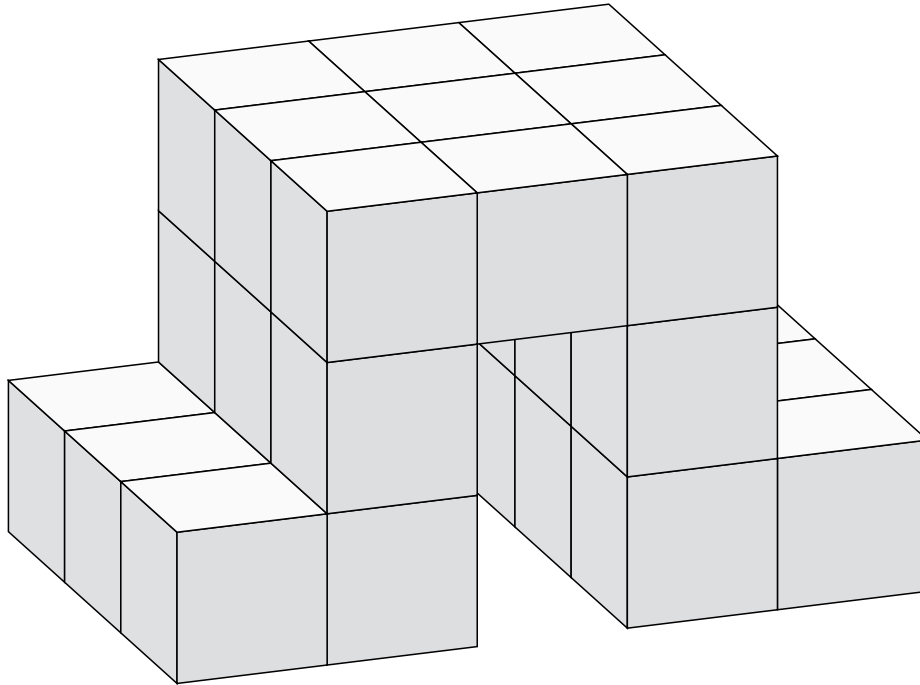

Tunnel



Eine mögliche Lösung

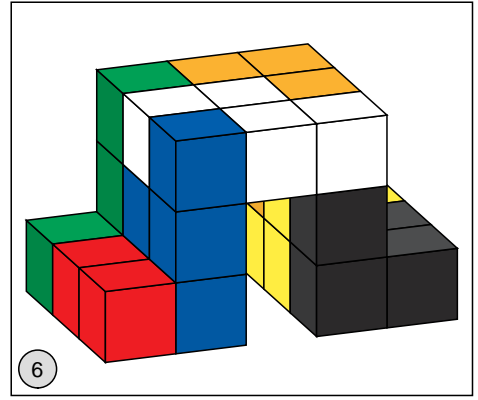
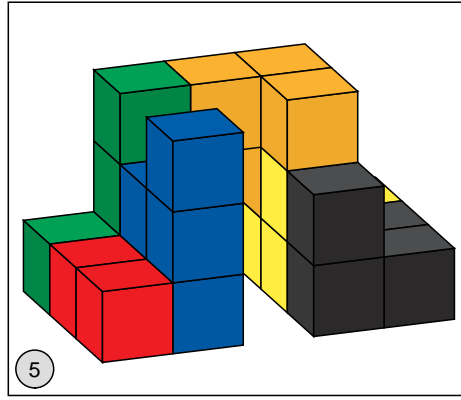
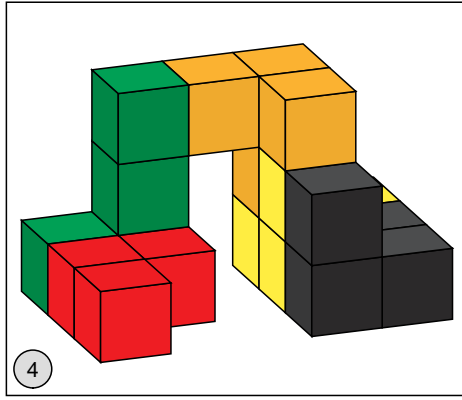
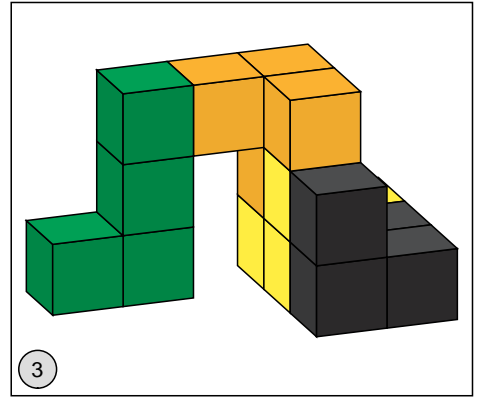
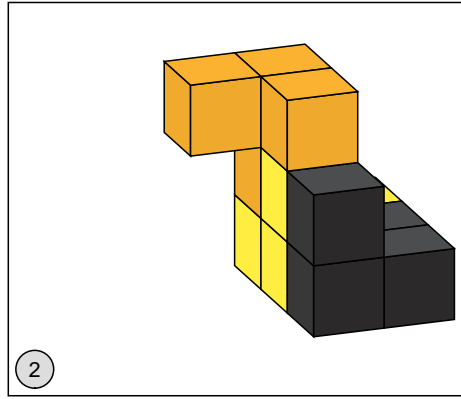
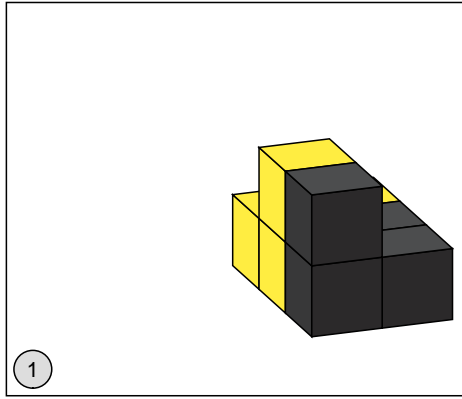

Somafiguren

24

Aufgabe: Baue das Sofa aus allen sieben Somateilen.

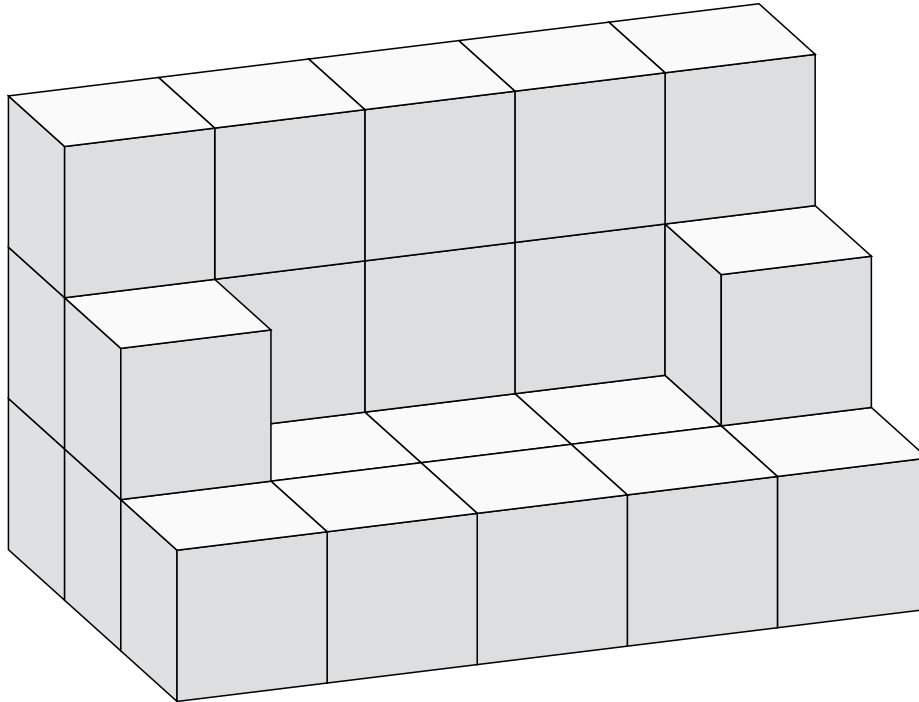

Sofa



Eine mögliche Lösung

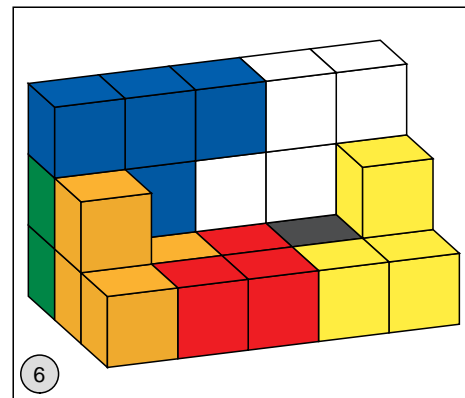
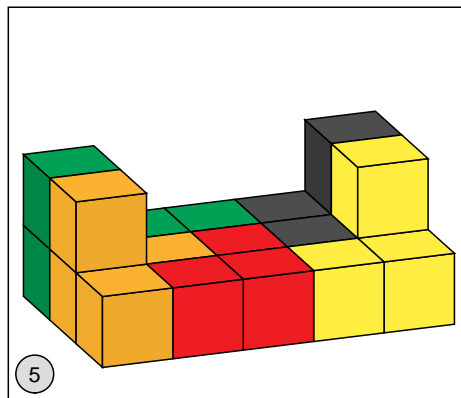
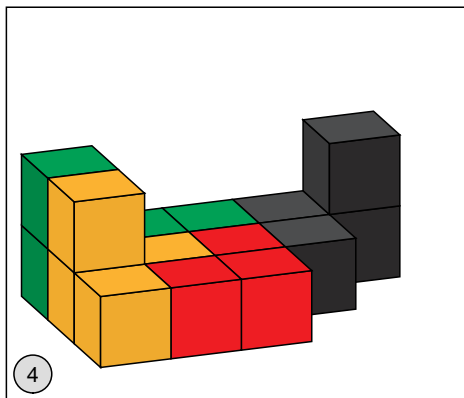
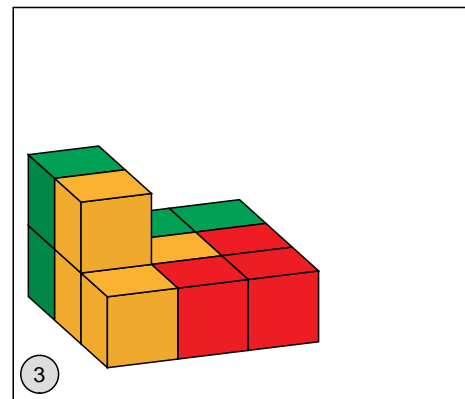
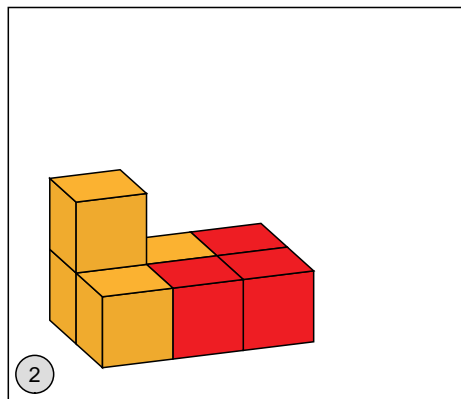
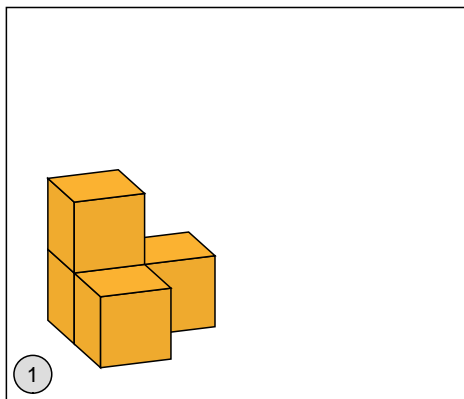

Somafiguren

25

Aufgabe: Baue den Würfel aus allen sieben Somateilen.

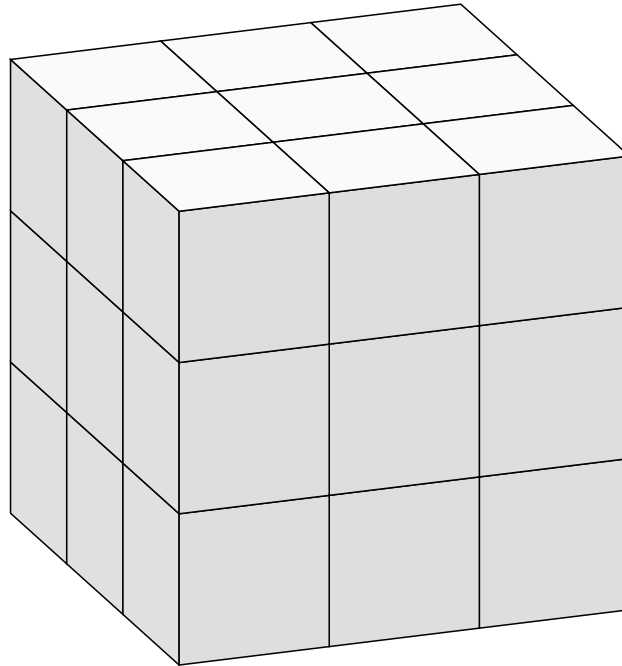

Würfel



Eine mögliche Lösung

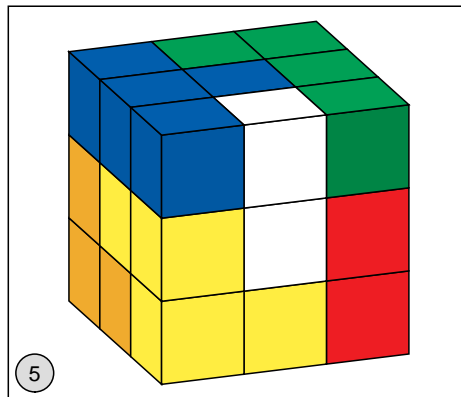
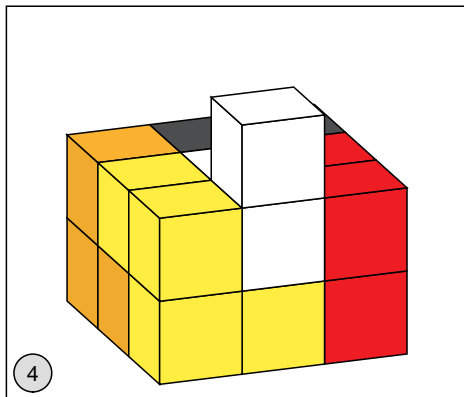
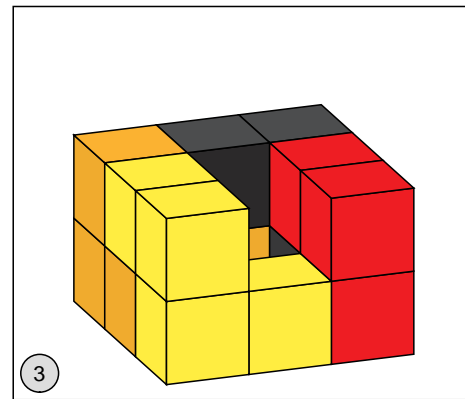
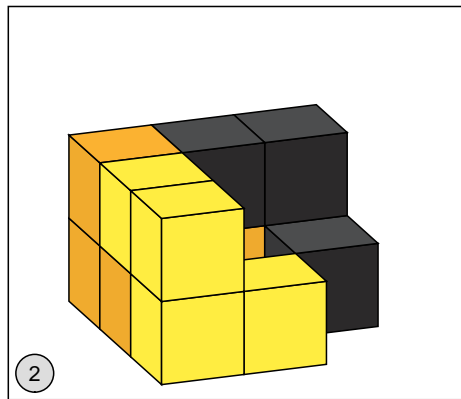
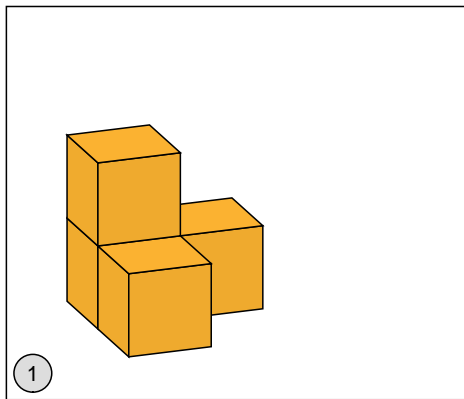

Somafiguren

26

Aufgabe: Baue die Siegertreppe aus allen sieben Somateilen.

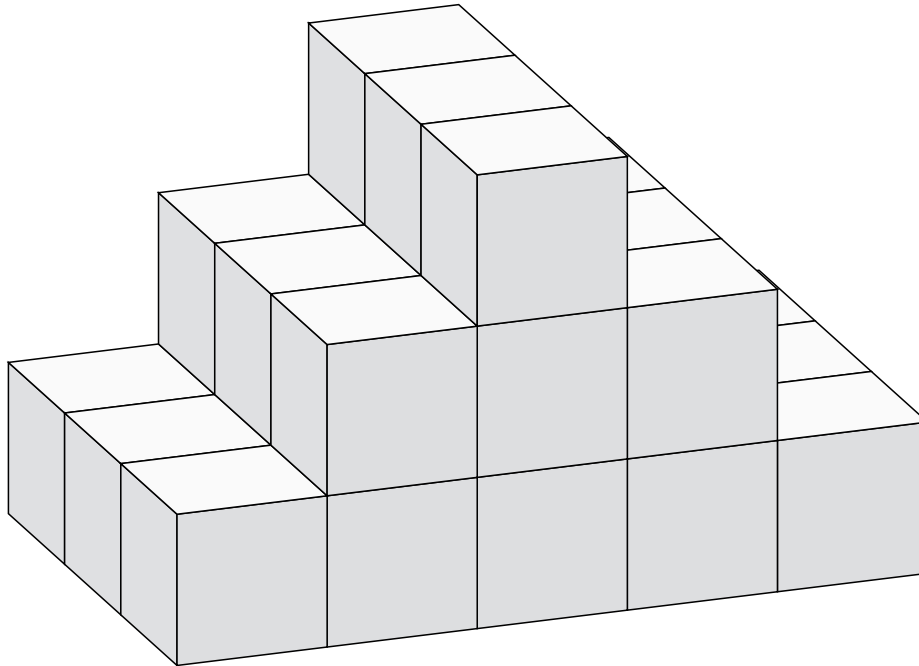

Siegertreppe



Eine mögliche Lösung

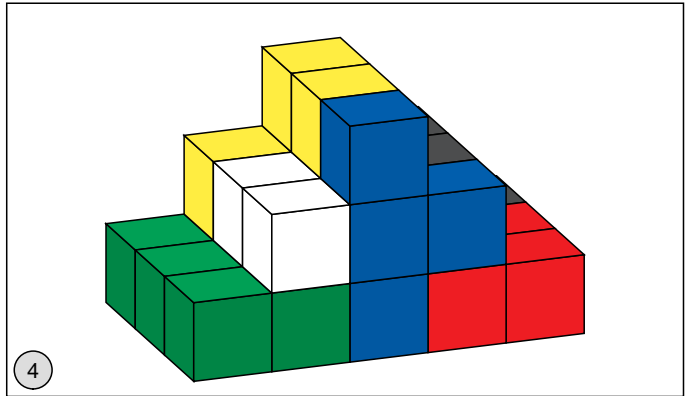
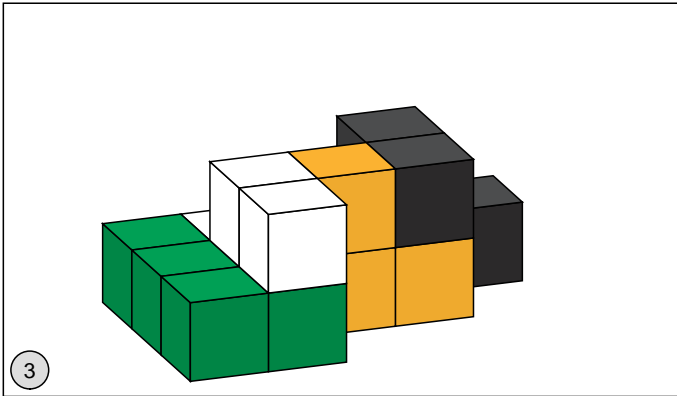
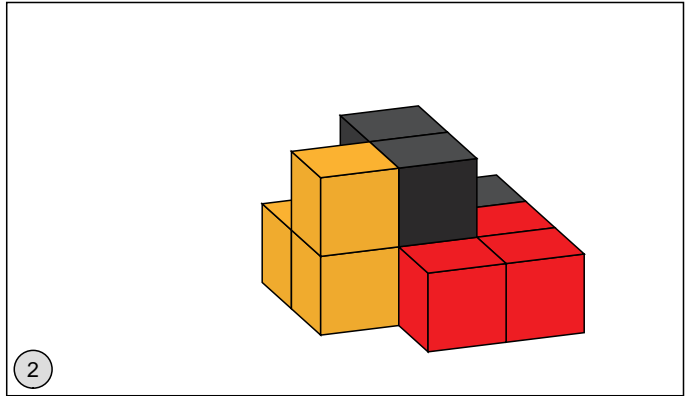
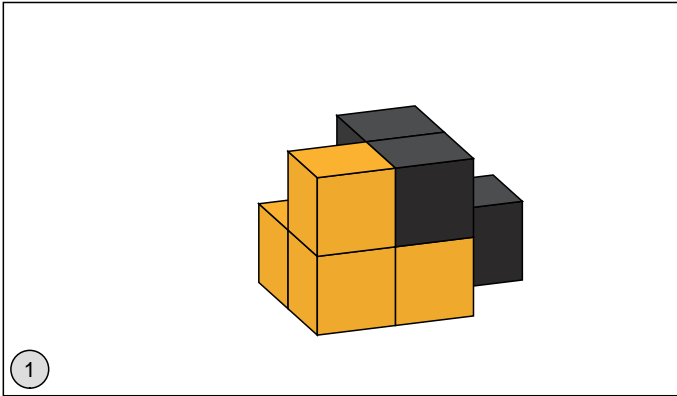

Somafiguren

27

Aufgabe: Baue die Brücke aus allen sieben Somateilen.

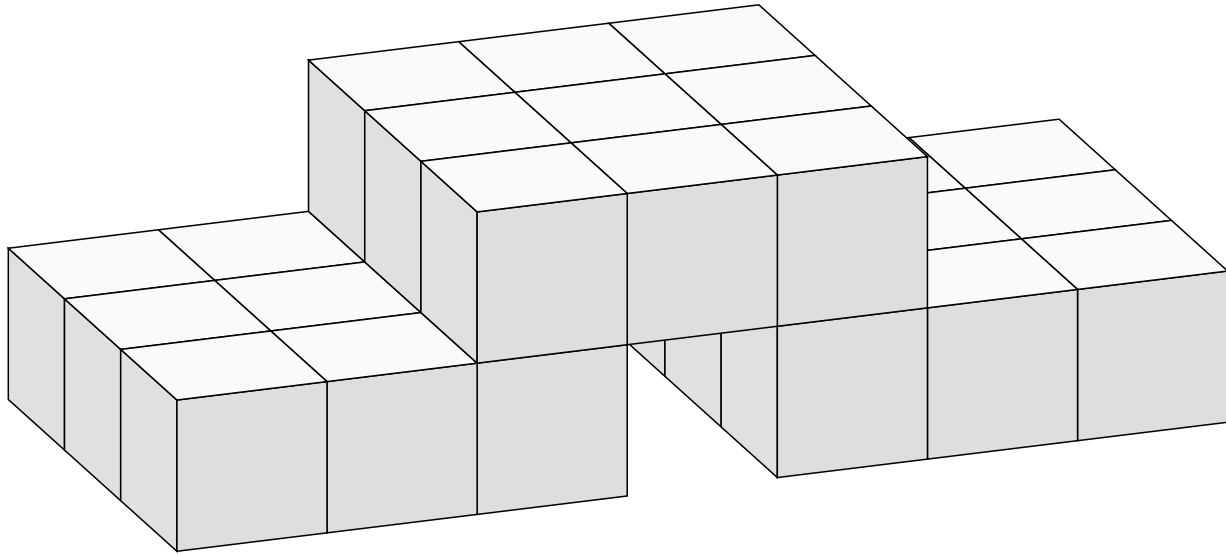

Brücke



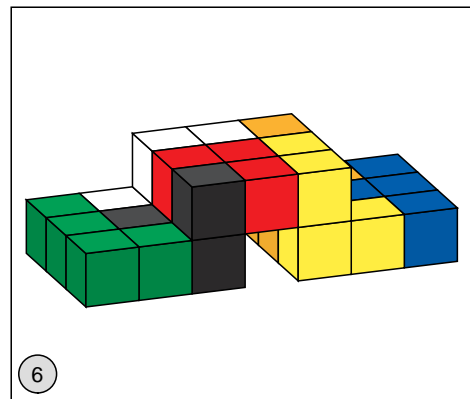
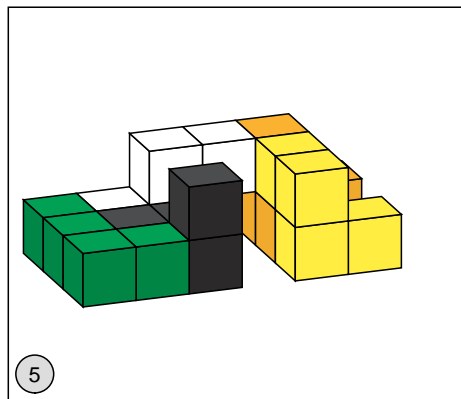
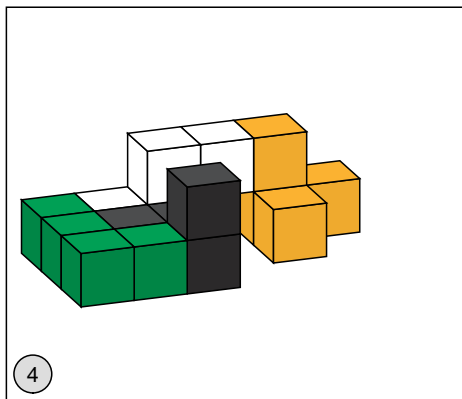
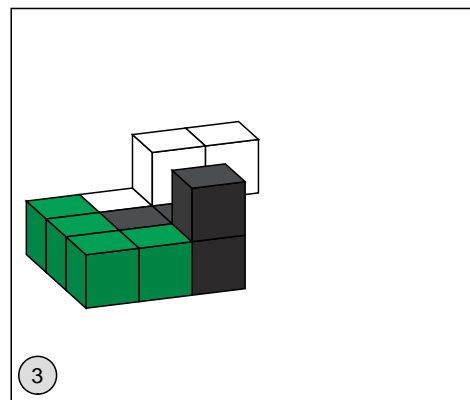
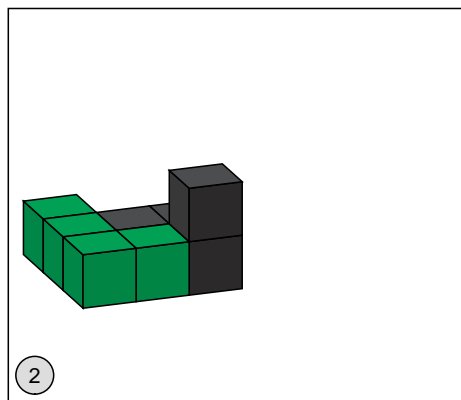
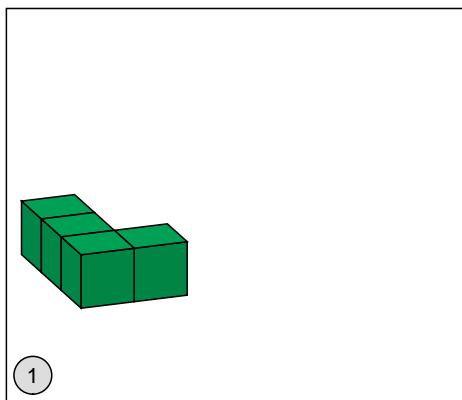

Somafiguren

28

Aufgabe: Baue den Regenwurm aus allen sieben Somateilen.

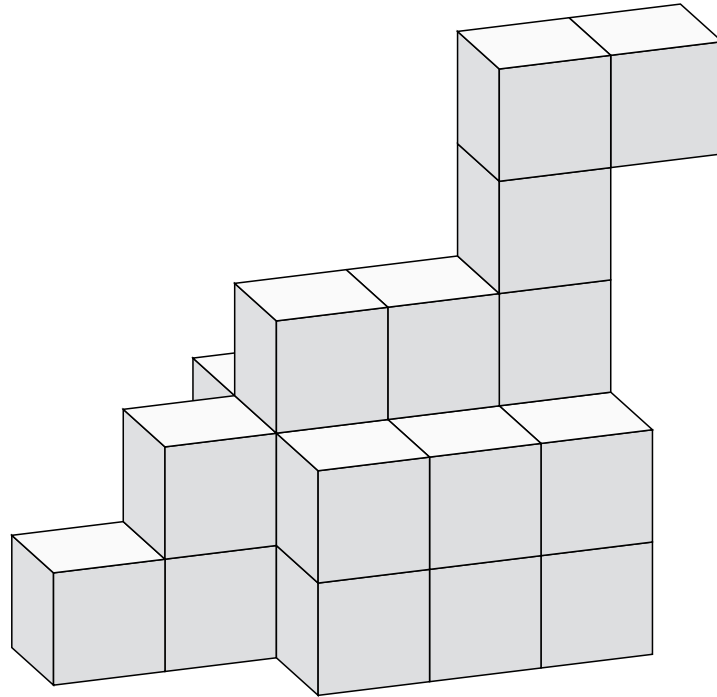

Regenwurm



Eine mögliche Lösung

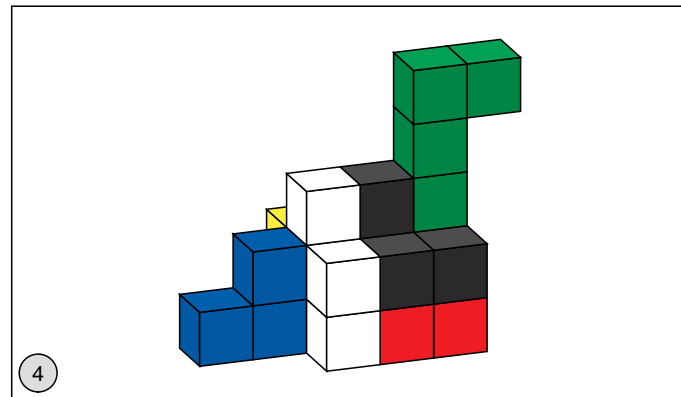
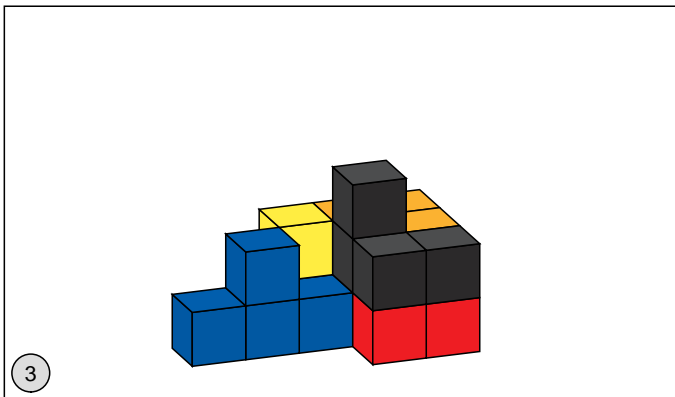
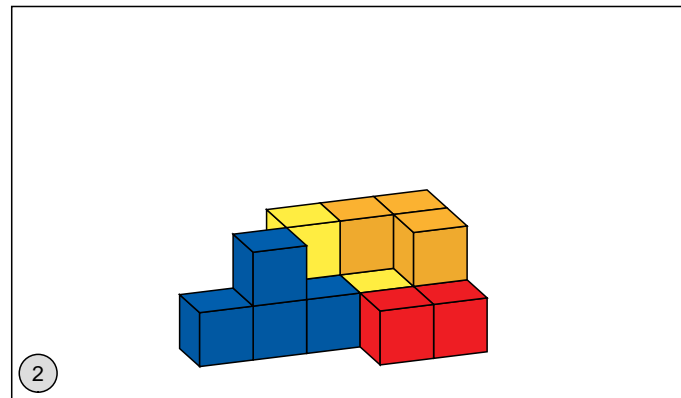
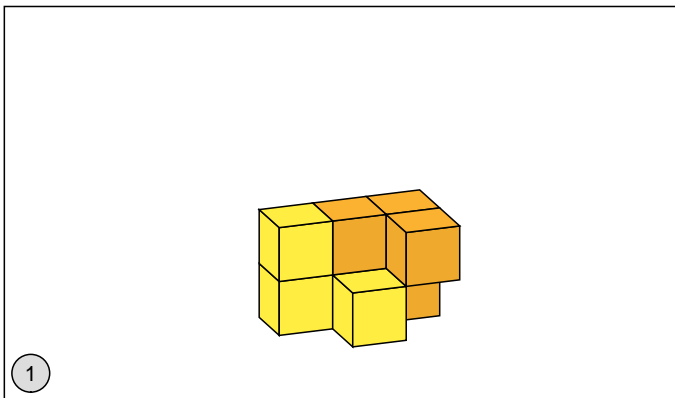

Somafiguren

29

Aufgabe: Baue den Brunnen aus allen sieben Somateilen.

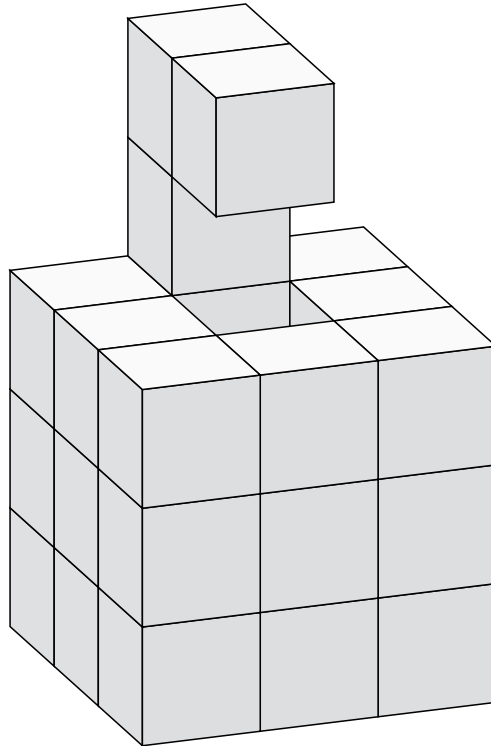

Brunnen



Idee: Lukas aus Münster

Eine mögliche Lösung

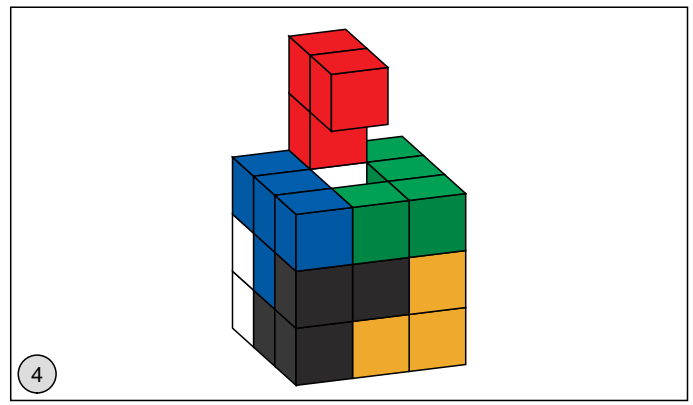
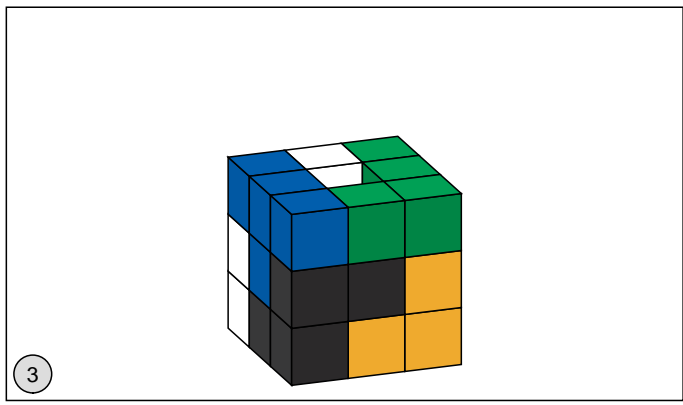
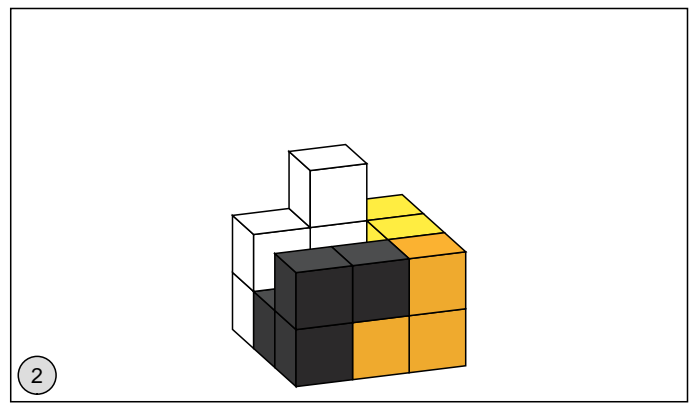
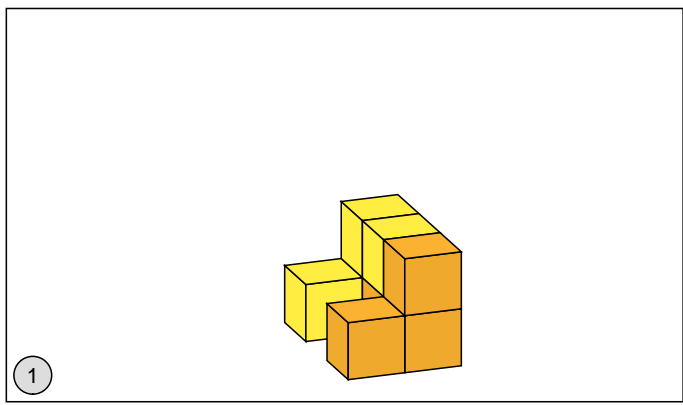

Somafiguren

30

Aufgabe: Baue das Bett aus allen sieben Somateilen.

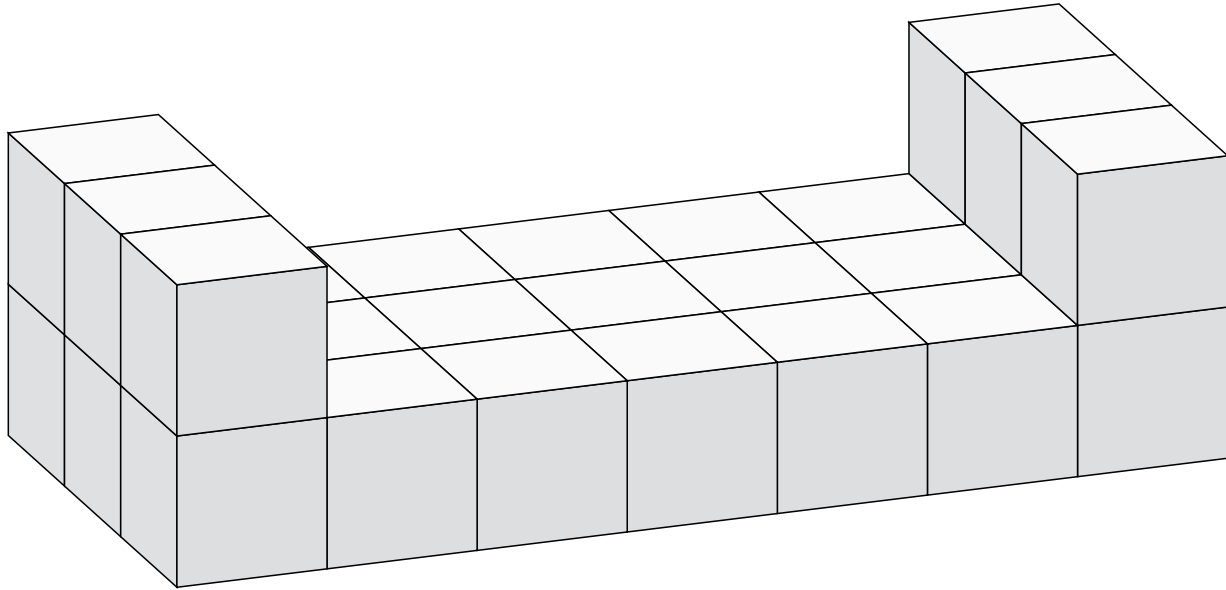

Bett



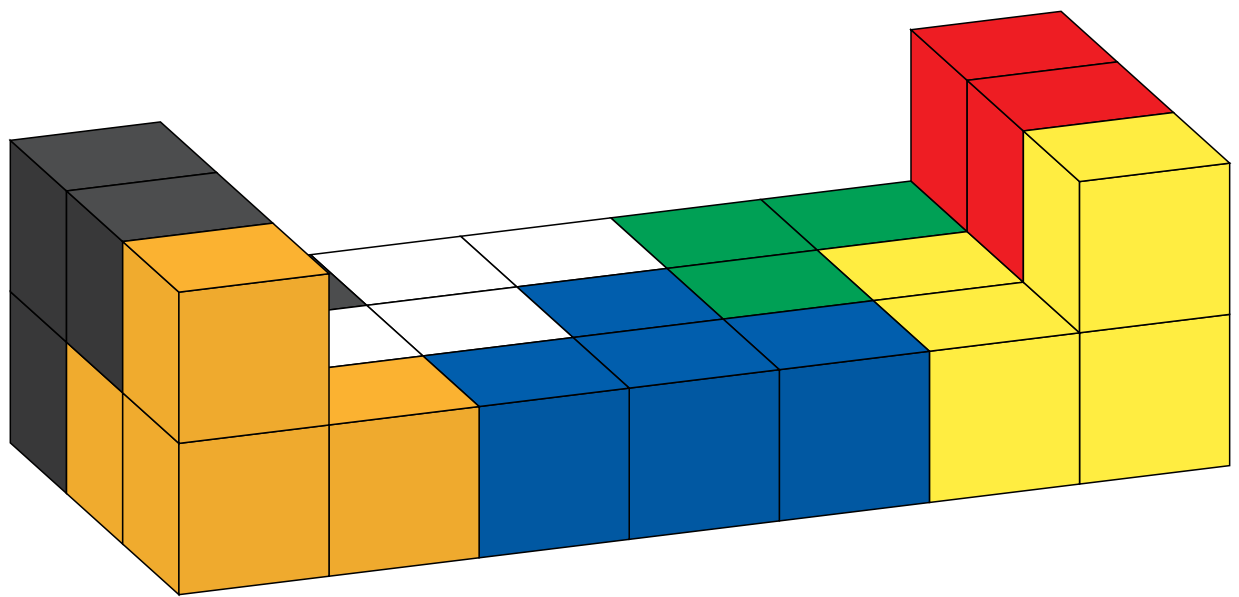

Somafiguren

31

Aufgabe: Baue den Skorpion aus allen sieben Somateilen.

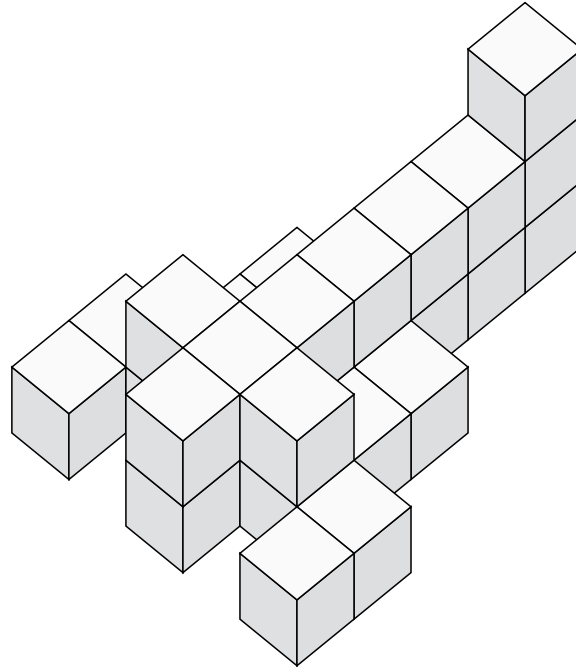

Skorpion



Eine mögliche Lösung

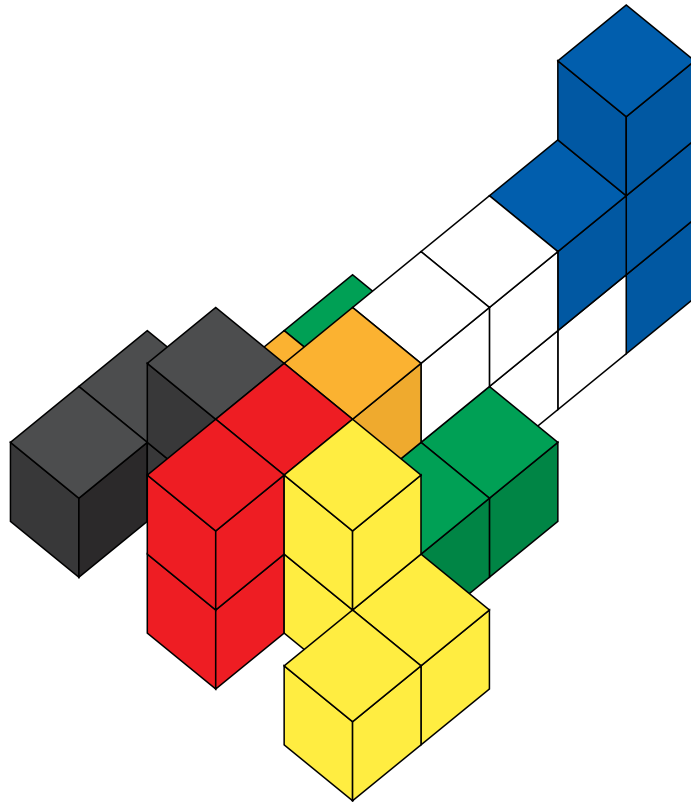

Somafiguren

32

Aufgabe: Baue den Hund aus allen sieben Somateilen.

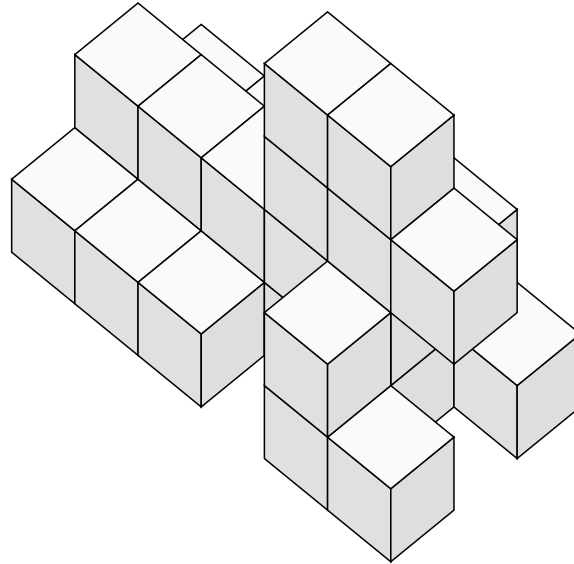

Hund



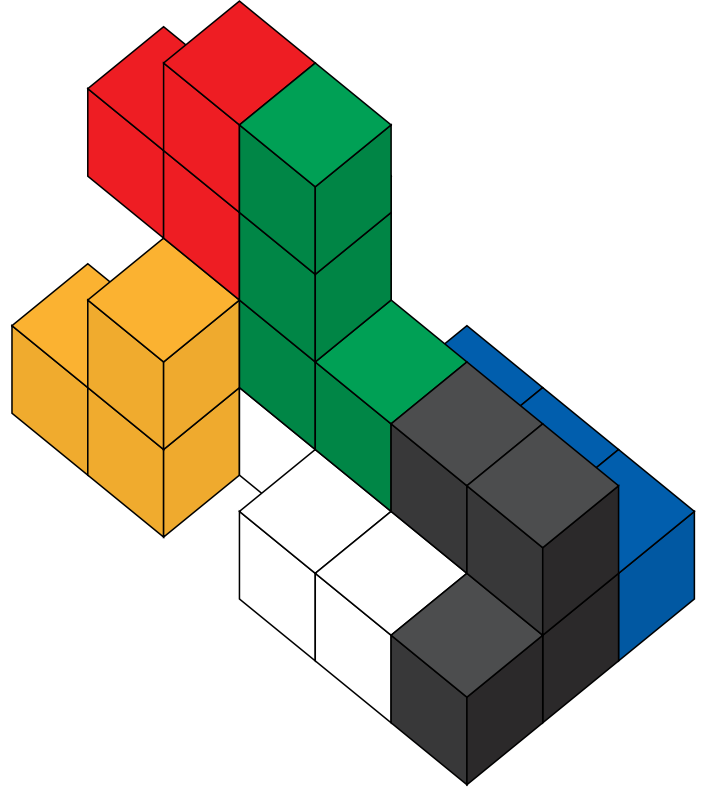
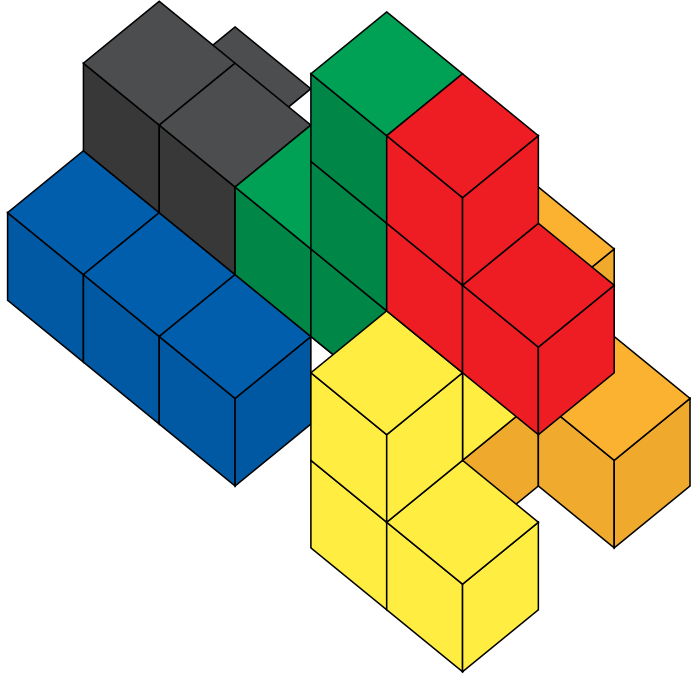

Somafiguren

33

Aufgabe: Baue die Schlange aus allen sieben Somateilen.

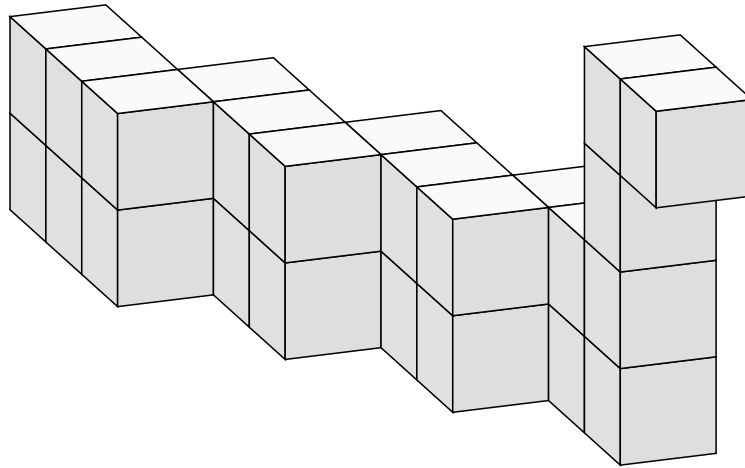

Schlange



Eine mögliche Lösung

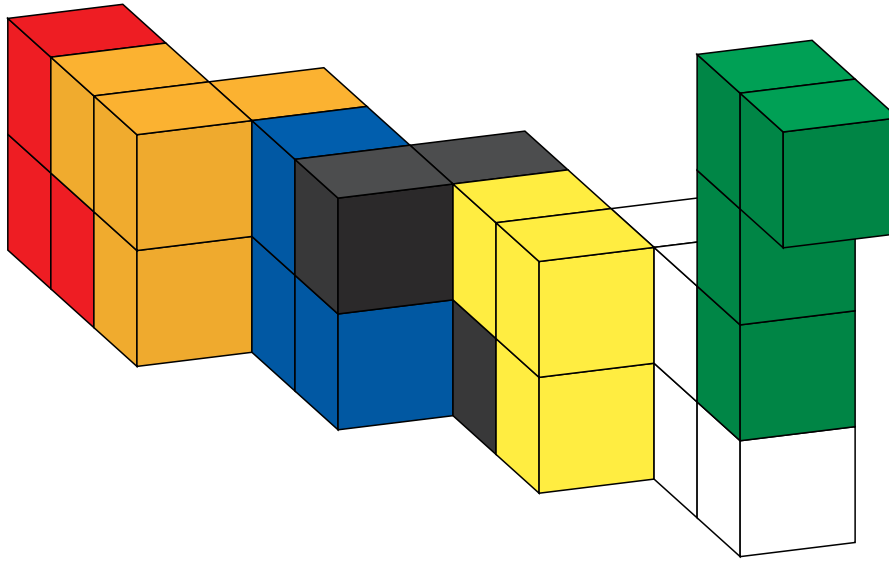

Somafiguren

34

Aufgabe: Baue das Kamel aus allen sieben Somateilen.

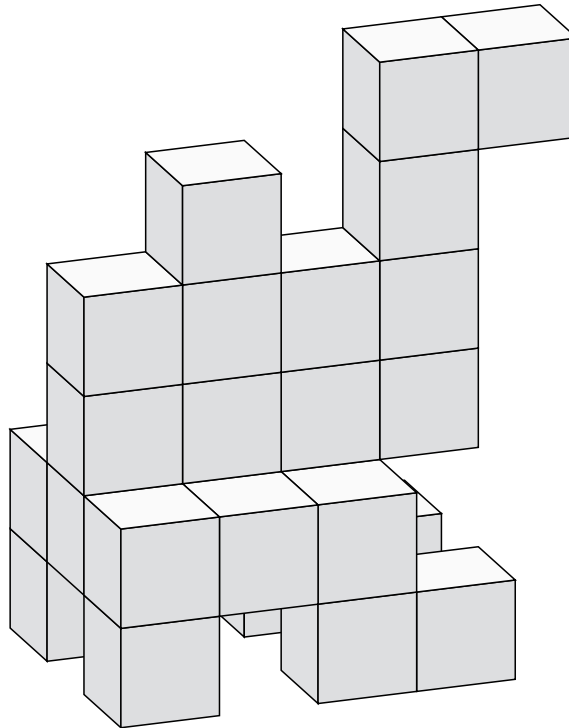

Kamel



Eine mögliche Lösung

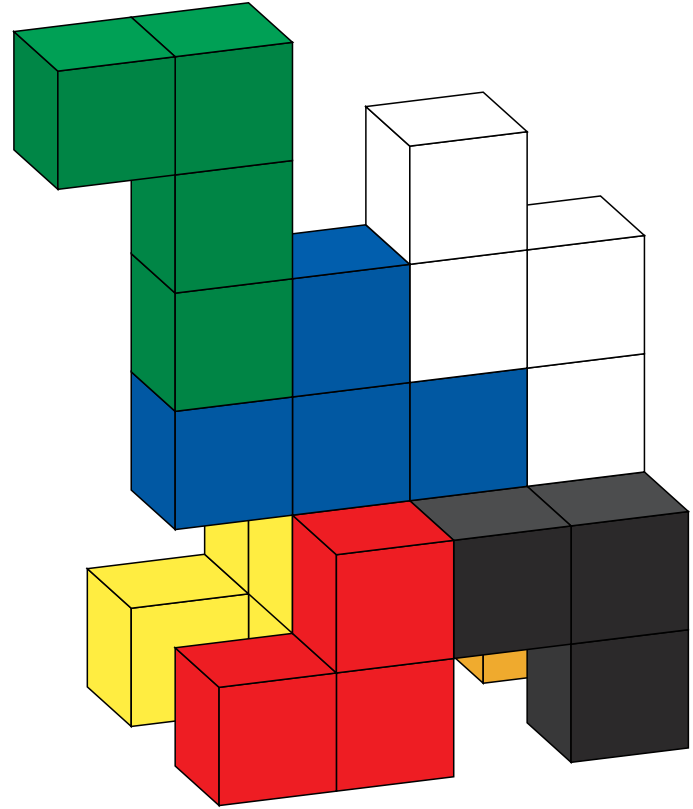
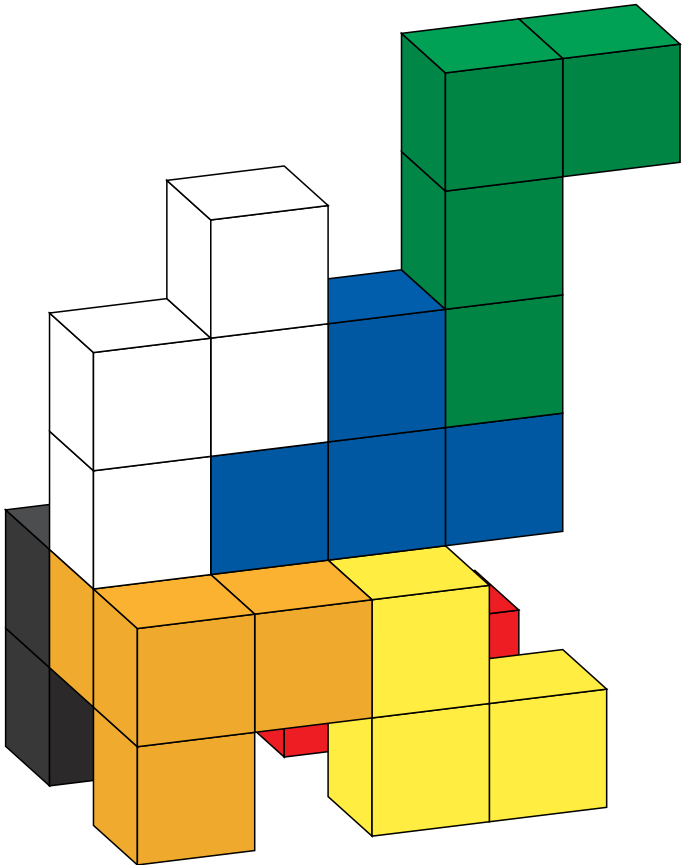

Somafiguren

35

Aufgabe: Baue die Katze aus allen sieben Somateilen.

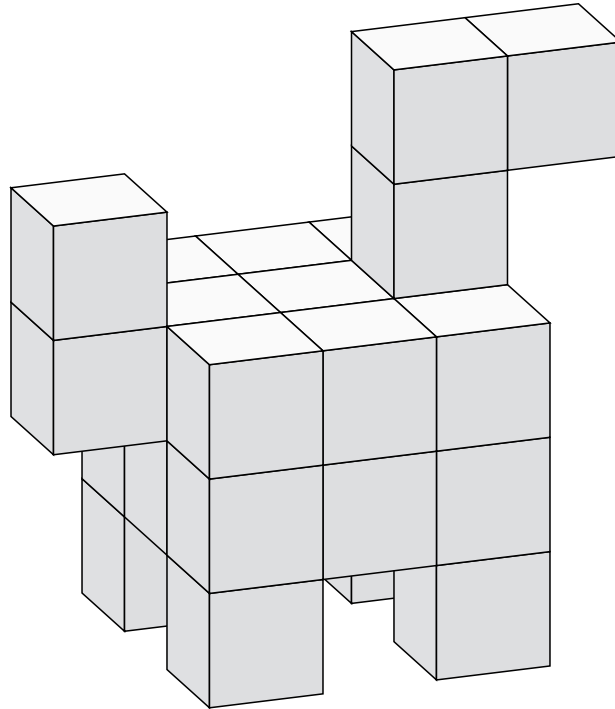

Katze



Eine mögliche Lösung

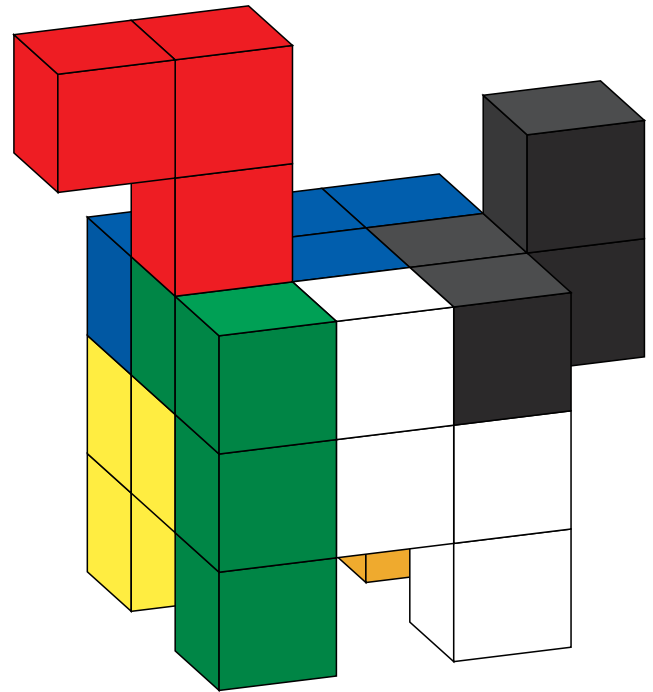
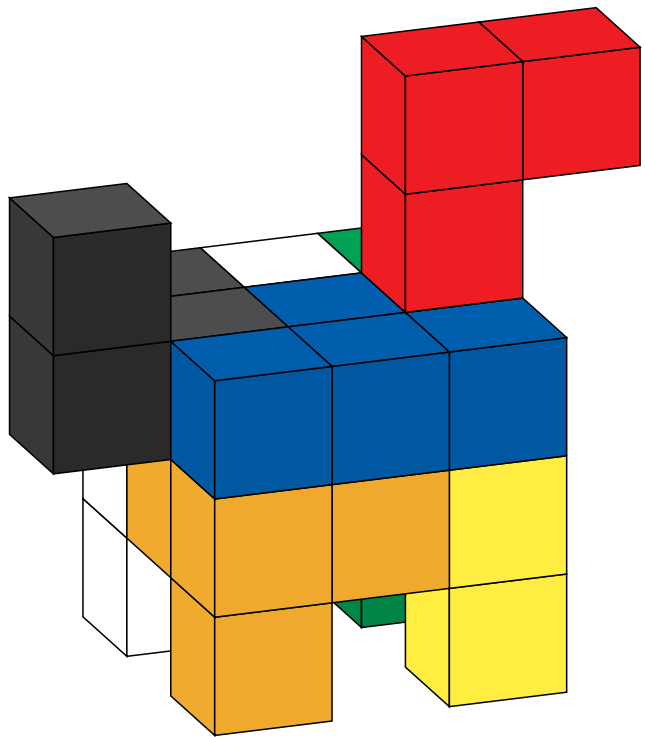

Somafiguren

36

Aufgabe: Baue den Wetterhahn aus allen sieben Somateilen.

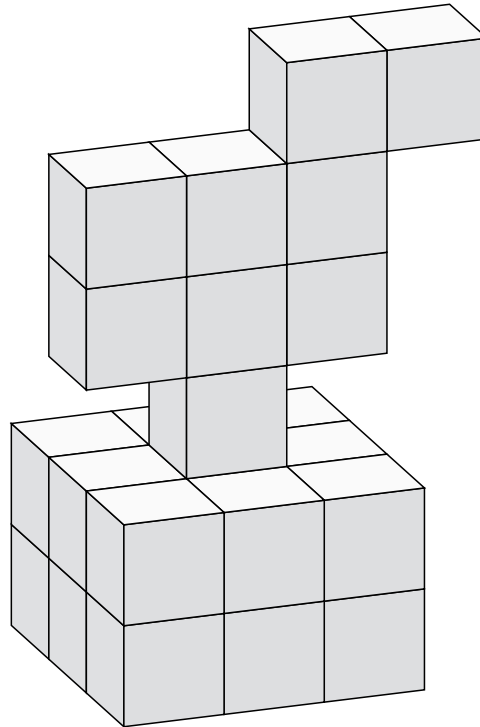

Wetterhahn



Eine mögliche Lösung

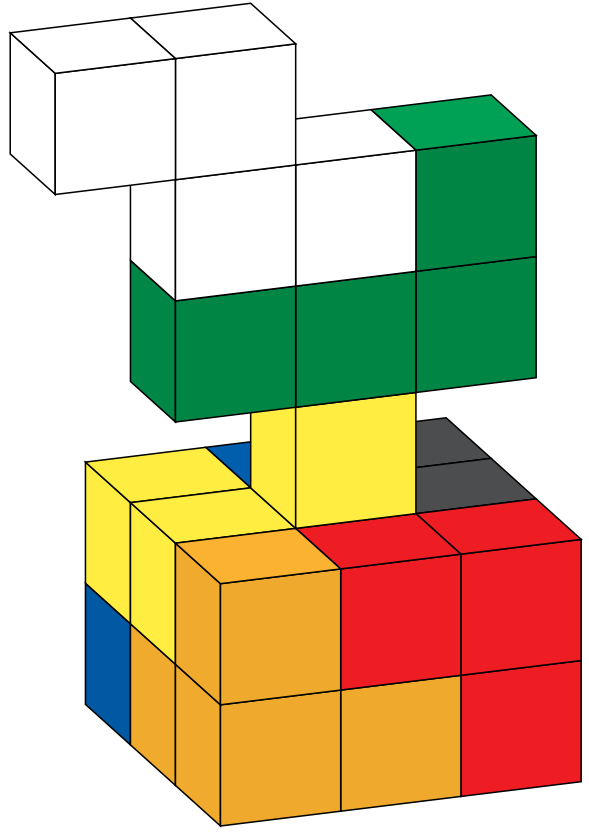
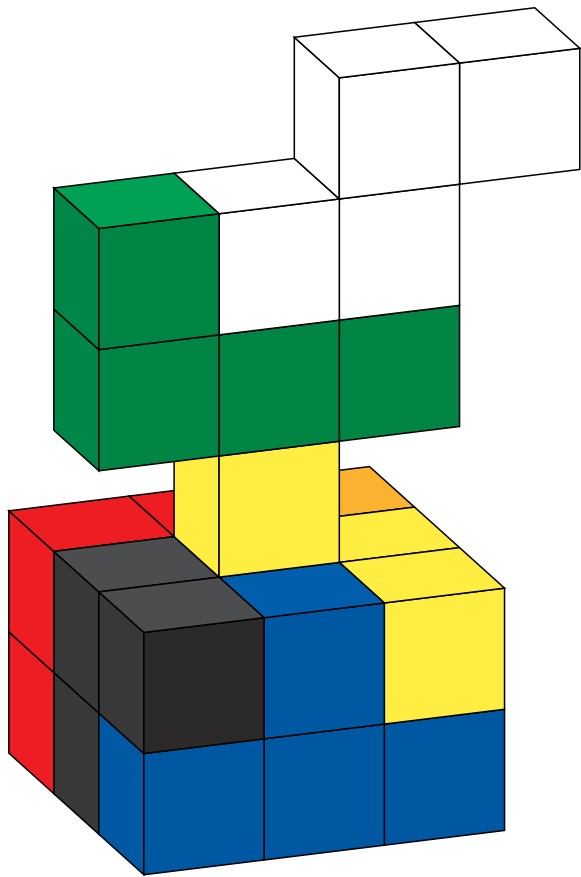

Somafiguren

37

Aufgabe: Baue die Giraffe aus allen sieben Somateilen.

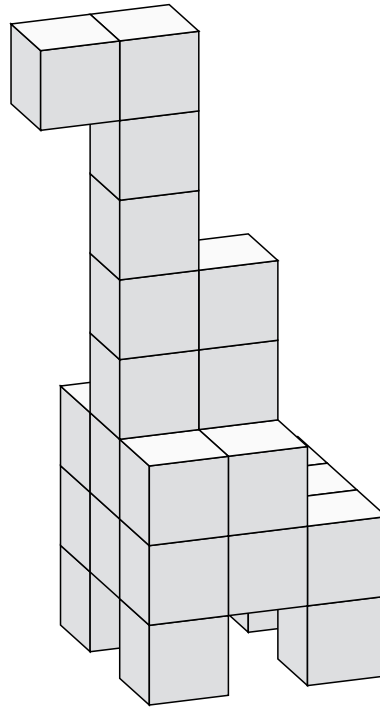

Giraffe



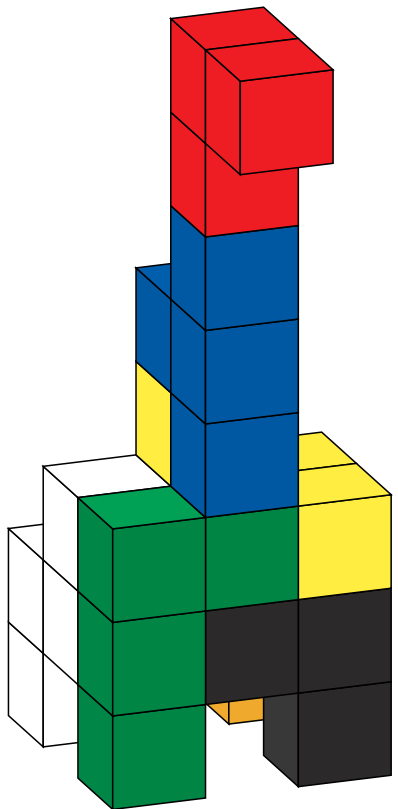
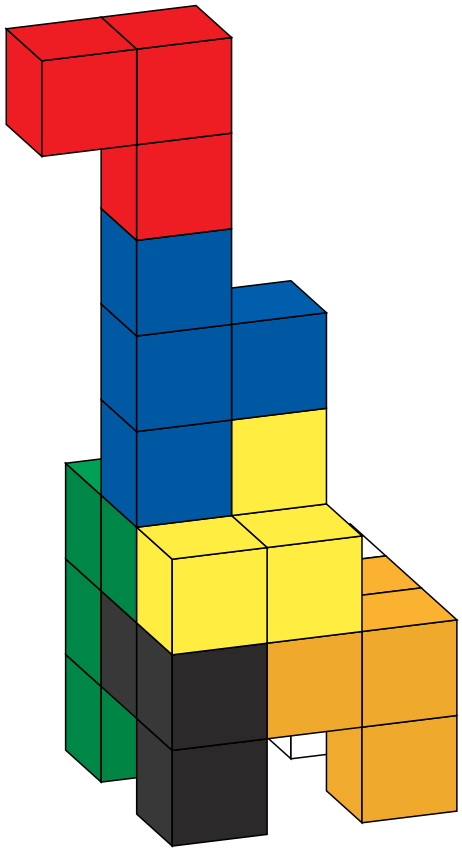

Somafiguren

38

Aufgabe: Baue die Schildkröte aus allen sieben Somateilen.

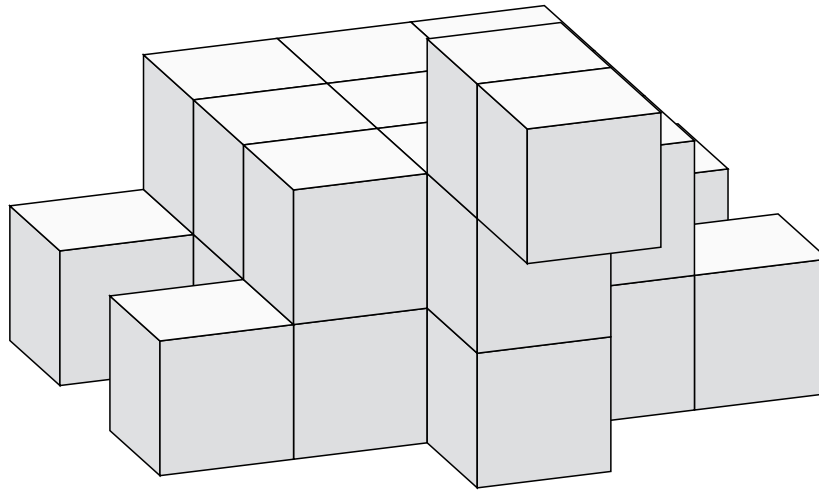

Schildkröte



Eine mögliche Lösung

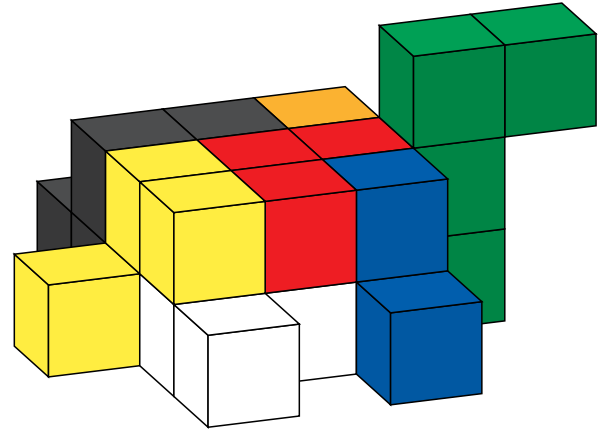
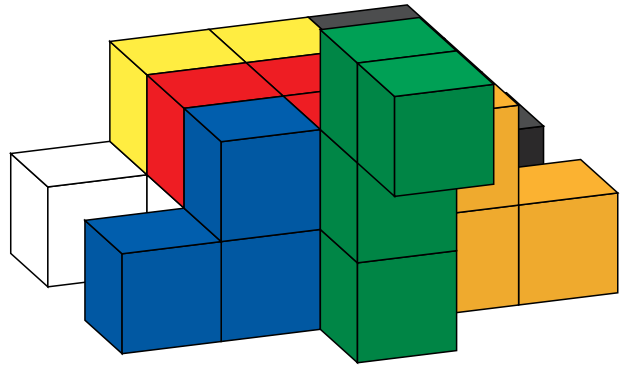

Somafiguren

39

Aufgabe: Baue die Schaufel aus allen sieben Somateilen.

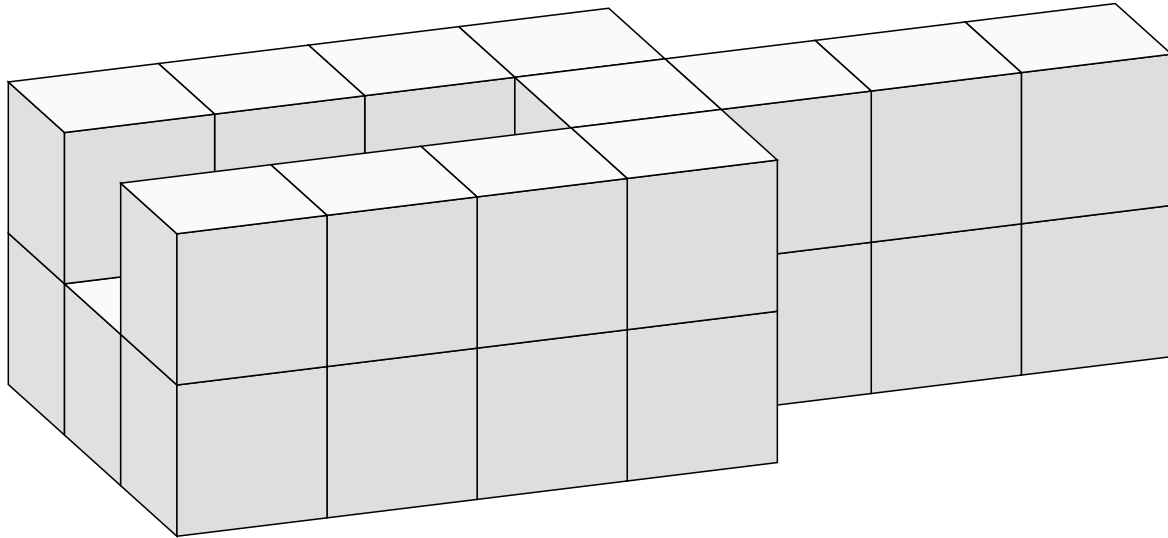

Schaufel



Eine mögliche Lösung

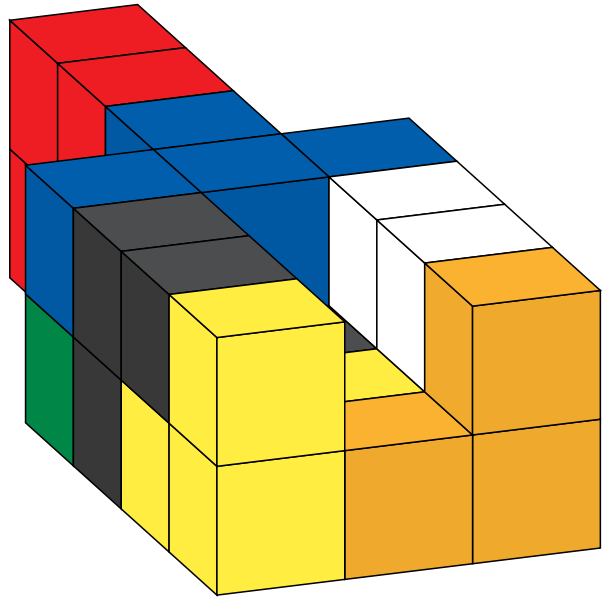
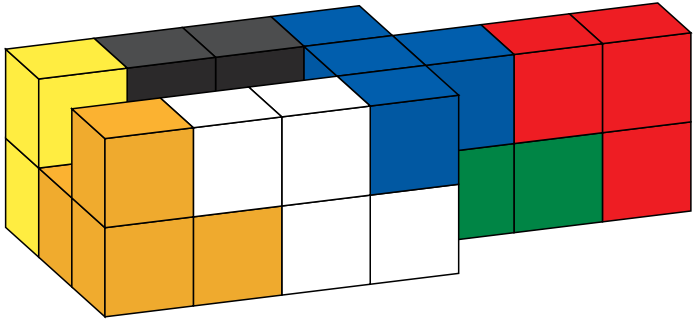

Somafiguren

40

Aufgabe: Baue die Mauer aus allen sieben Somateilen.

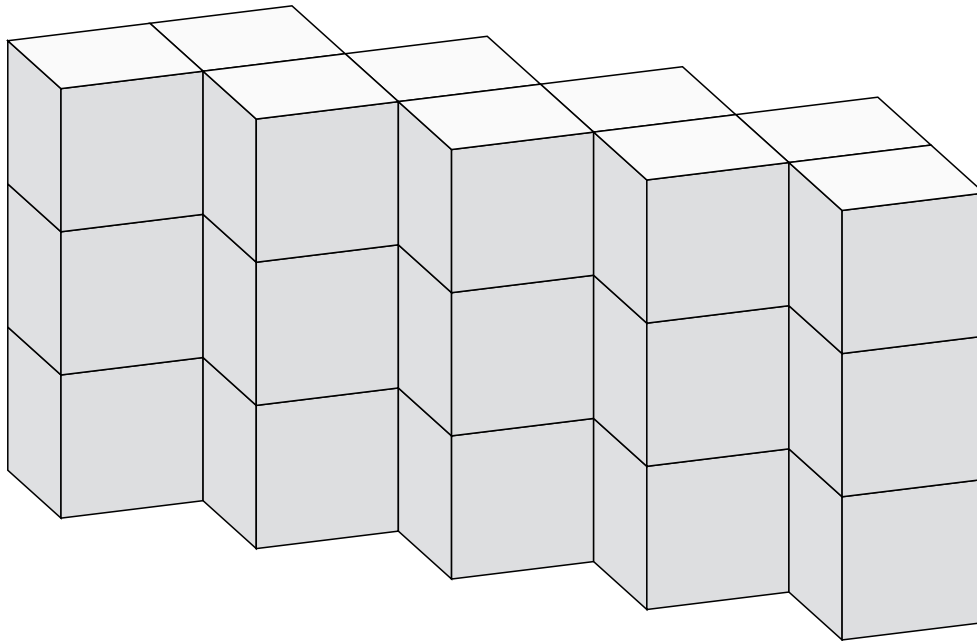

Mauer



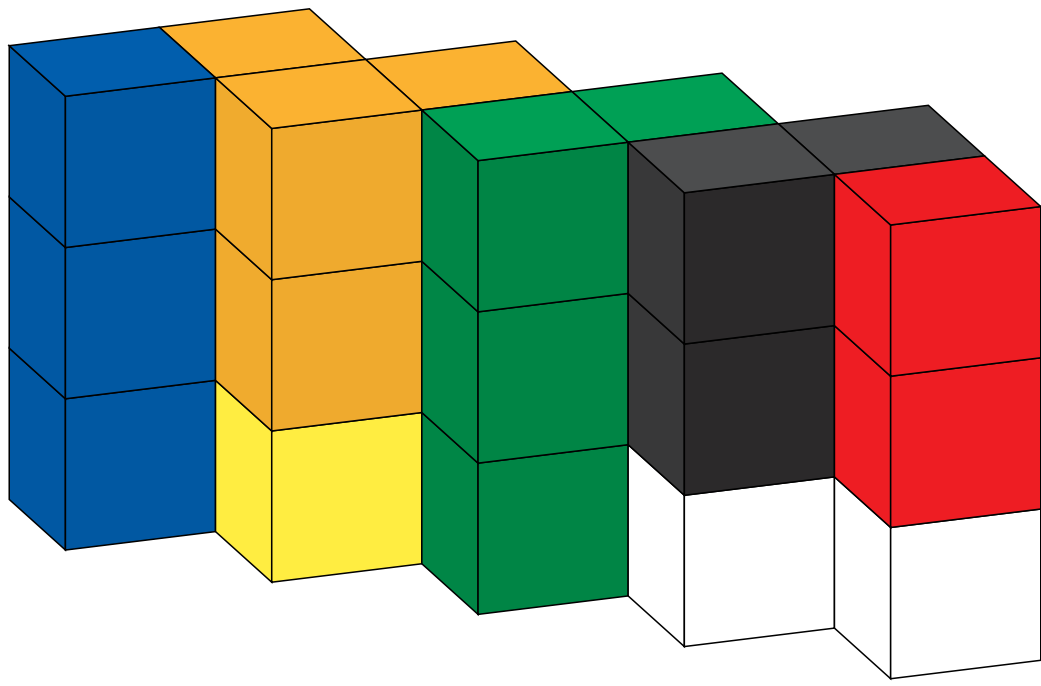

Somafiguren

41

Aufgabe: Baue den Schlüssel aus allen sieben Somateilen.

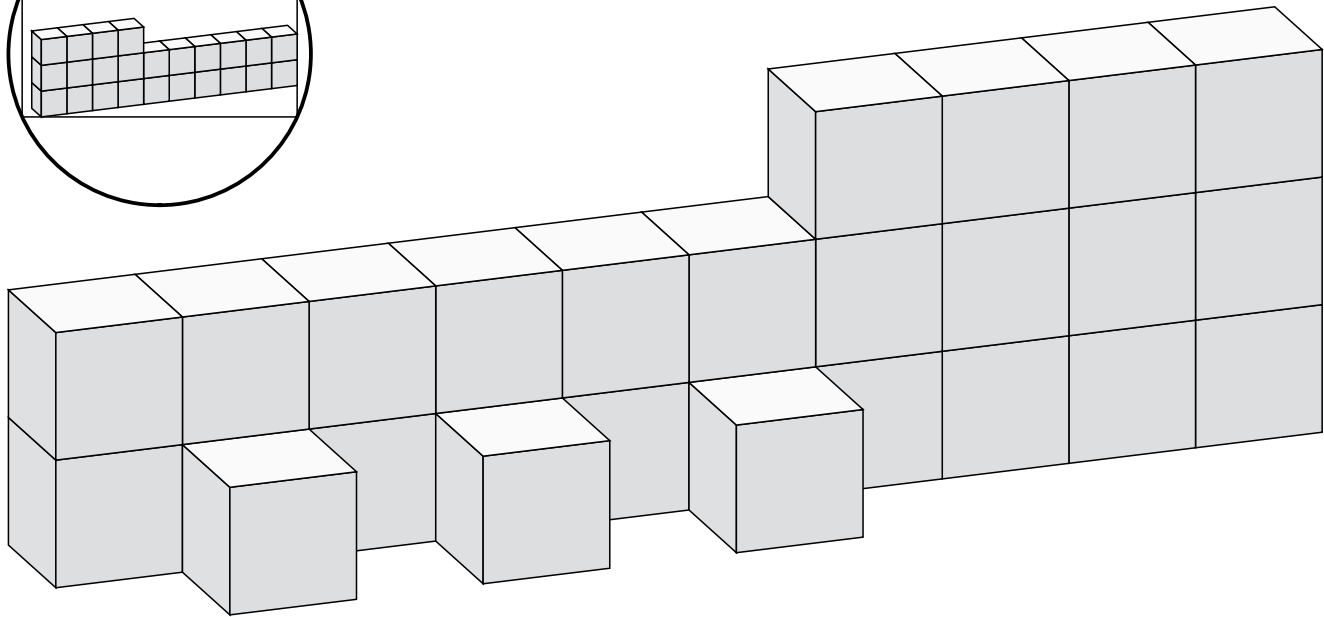
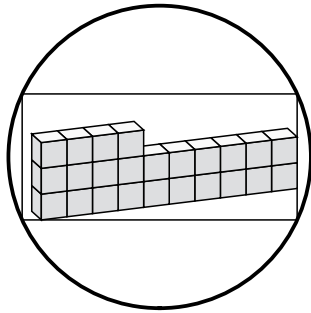

Schlüssel



Eine mögliche Lösung

