

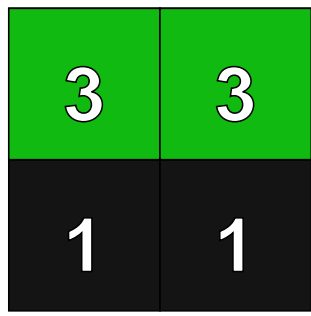

Soma-Baupläne

Aufgabe: Baue die Figur aus zwei Somateilen nach dem Bauplan.

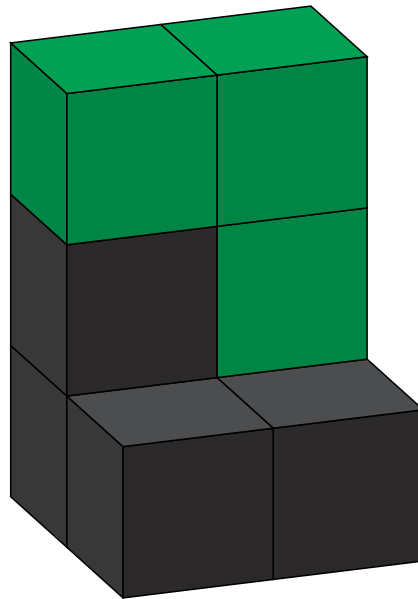





Soma-Baupläne

Aufgabe: Baue die Figur aus drei Somateilen nach dem Bauplan.

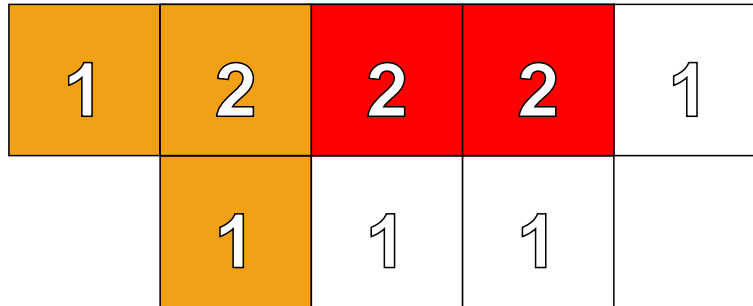

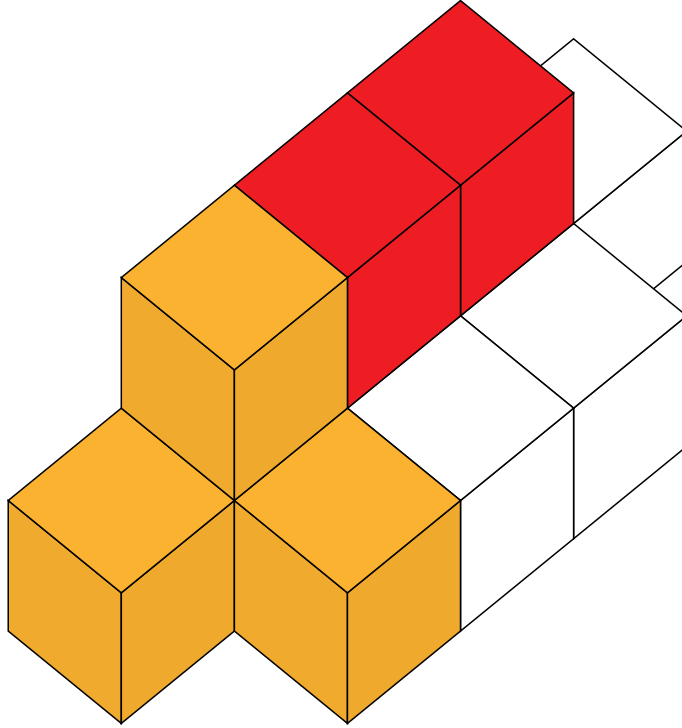



Soma-Baupläne

Aufgabe: Baue die Figur aus drei Somateilen nach dem Bauplan.

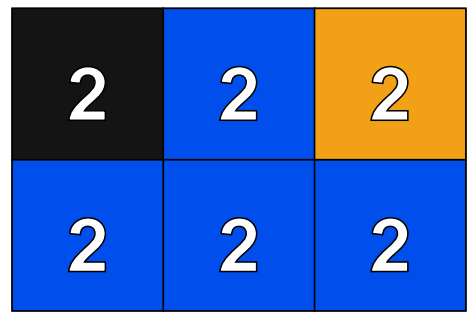

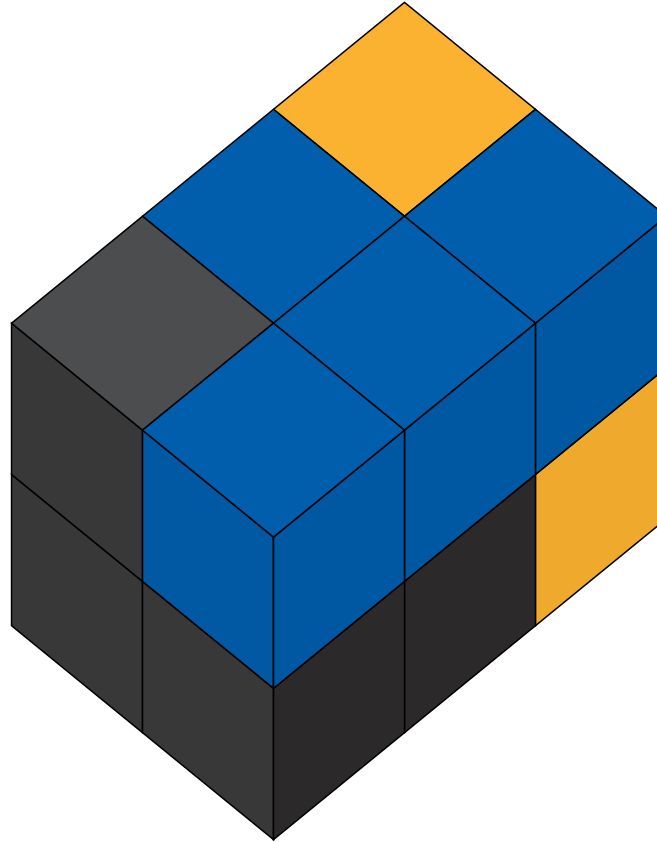

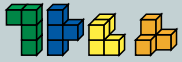

Soma-Baupläne

Aufgabe: Baue die Figur aus vier Somateilen nach dem Bauplan.

1	2	1	1
2	1	2	1
1	2	1	1



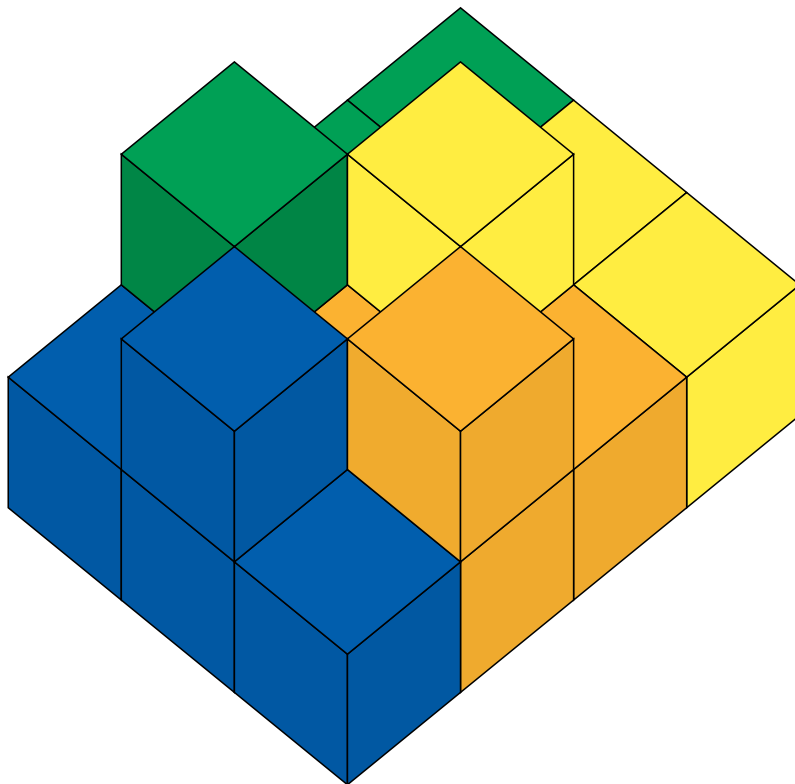

Soma-Baupläne

5

Aufgabe: Baue die Figur aus allen sieben Somateilen nach dem Bauplan.

2	1	1	1	2
1	1	1	1	1
1	1	1	1	1
1	1	1	1	1
2	1	1	1	



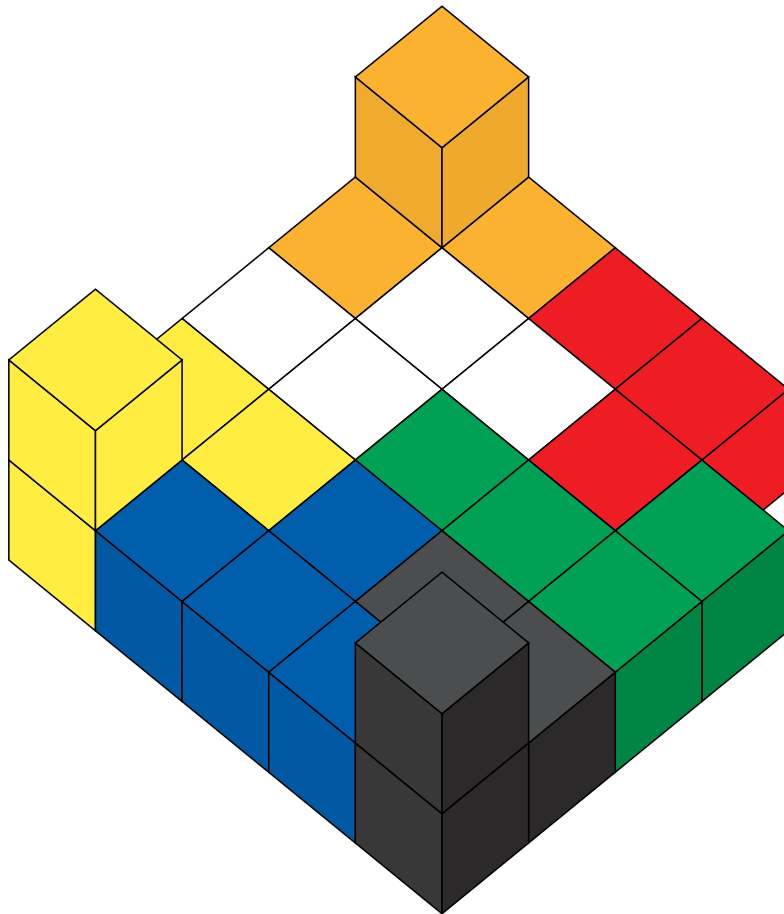



Soma-Baupläne

Aufgabe: Baue die Figur aus vier Somateilen nach dem Bauplan.

1	2	2
2	2	2
1	2	2



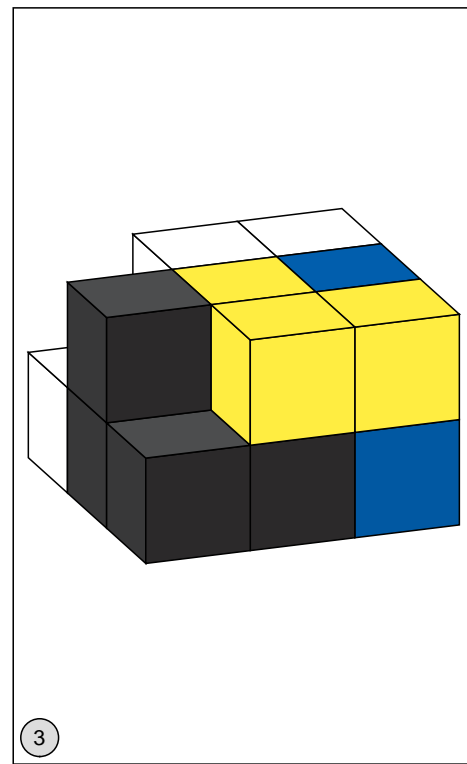
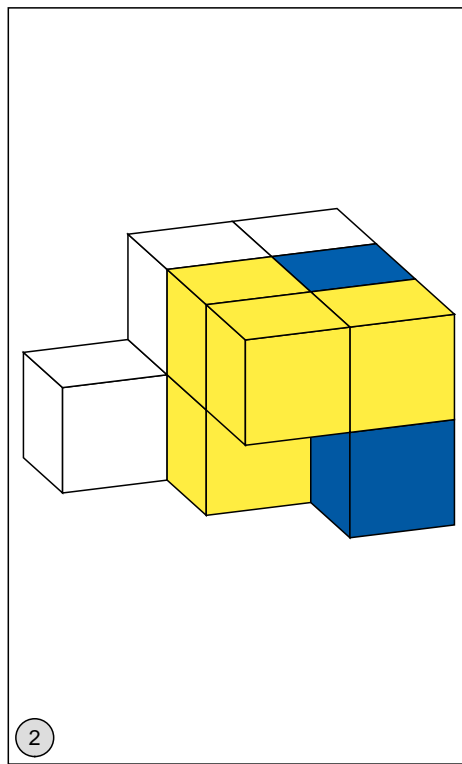
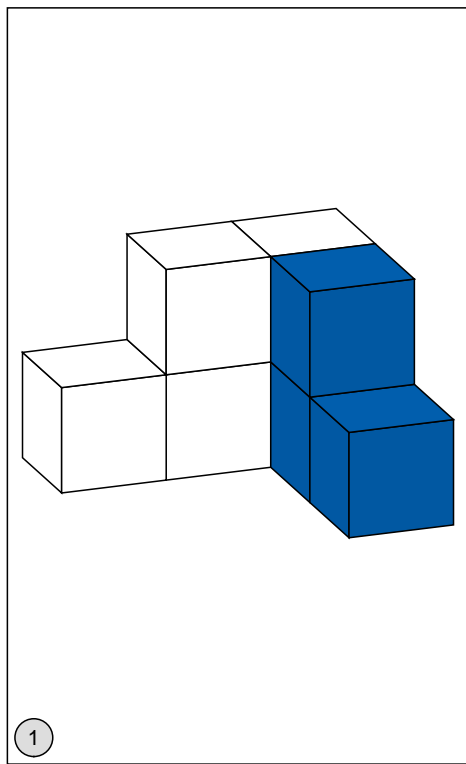



Soma-Baupläne

Aufgabe: Baue die Figur aus vier Somateilen nach dem Bauplan.

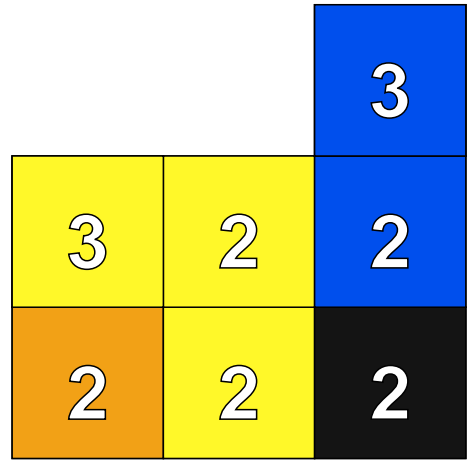

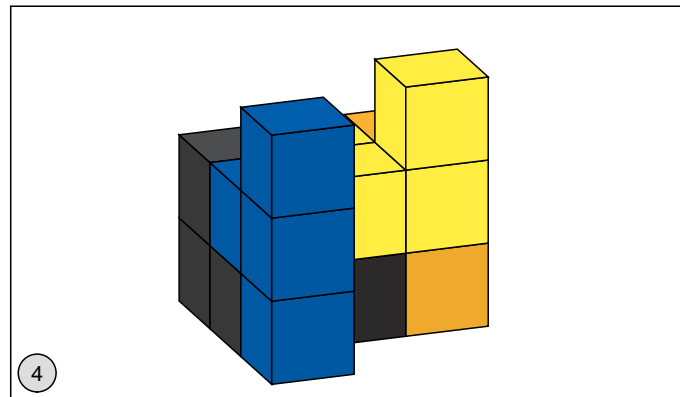
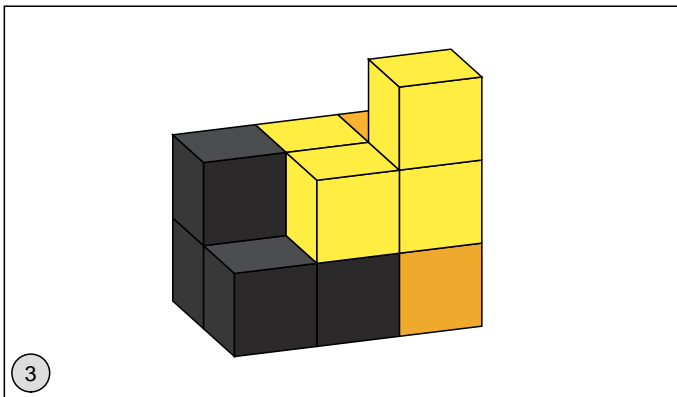
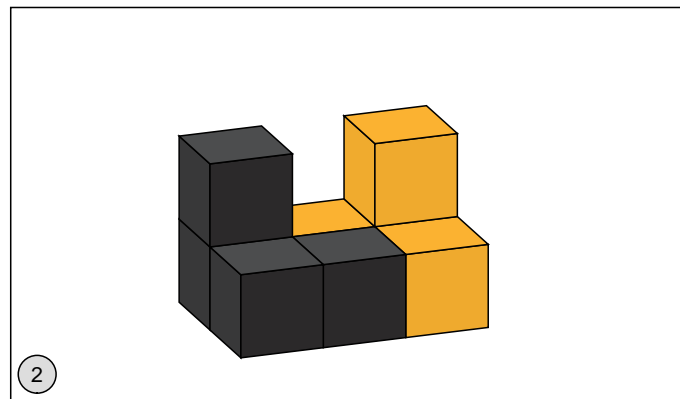
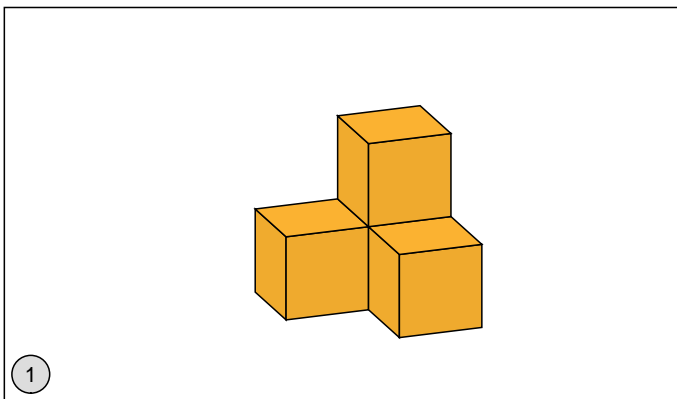



Soma-Baupläne

Aufgabe: Baue die Figur aus fünf Somateilen nach dem Bauplan.

1	2	1	1
2	3	4	1
1	2	1	1



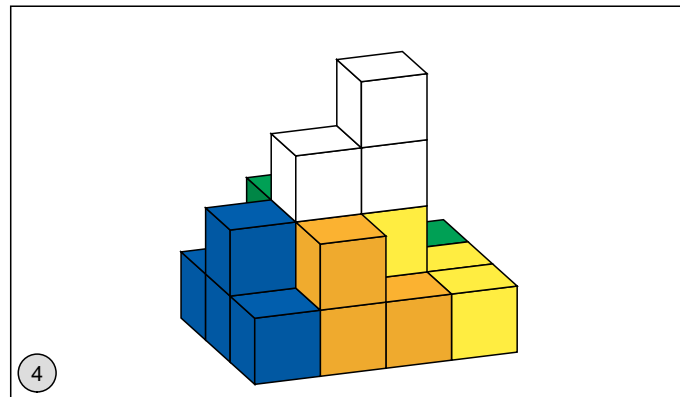
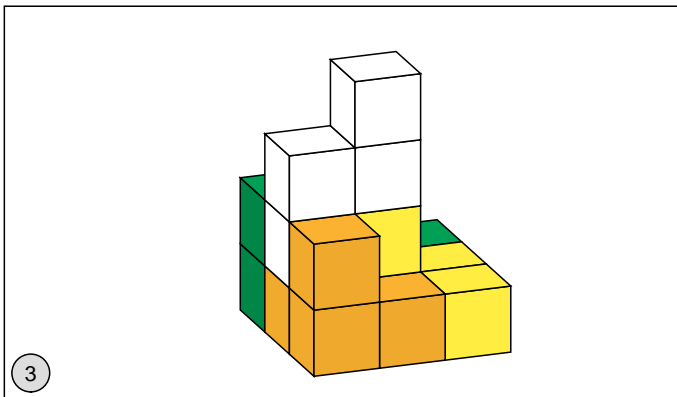
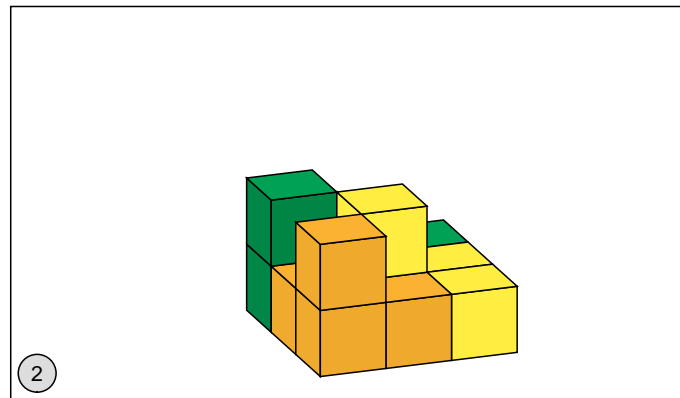
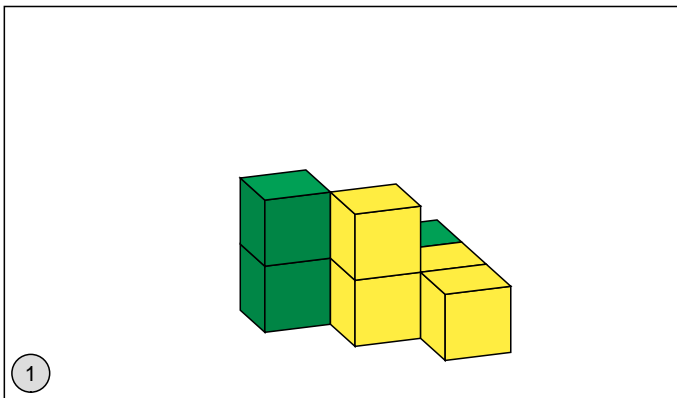



Soma-Baupläne

Aufgabe: Baue die Figur aus fünf Somateilen nach dem Bauplan.

3	3	1
3	2	3
1	3	1



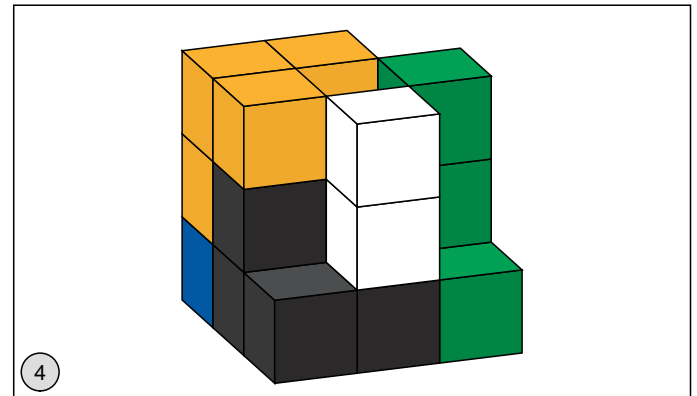
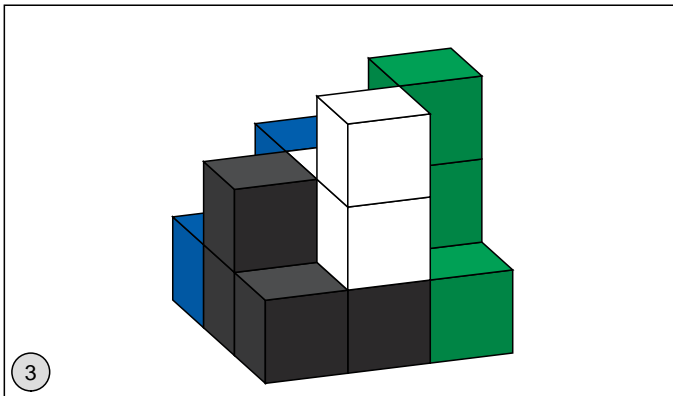
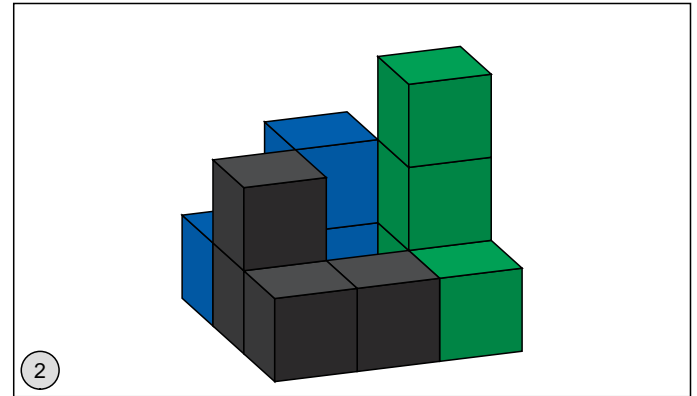
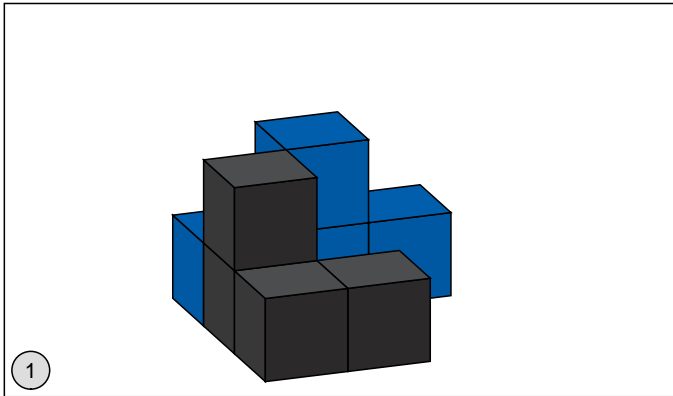

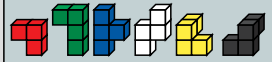

Soma-Baupläne

Aufgabe: Baue die Figur aus sechs Somateilen nach dem Bauplan.

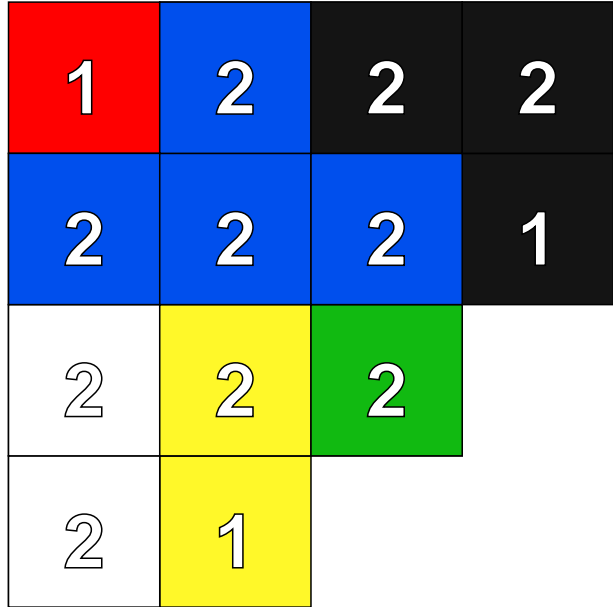

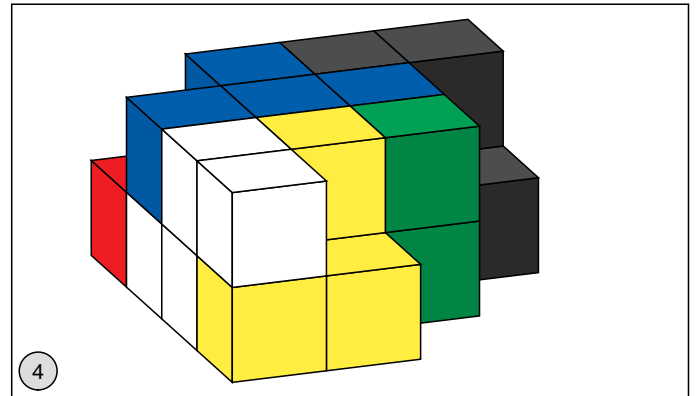
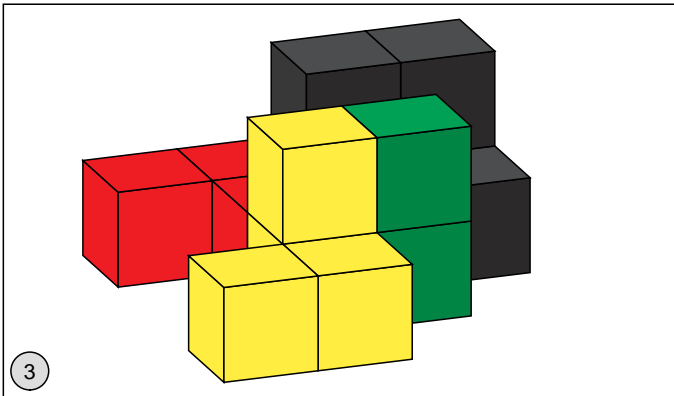
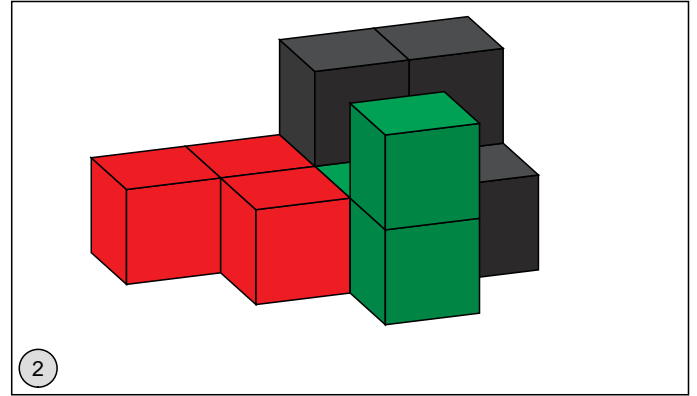
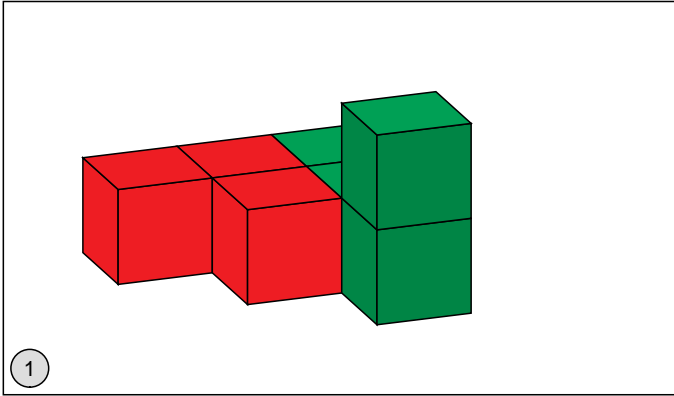



Soma-Baupläne

Aufgabe: Baue die Figur aus sechs Somateilen nach dem Bauplan.

3	1	1	1
3	3	3	2
3	1	1	1



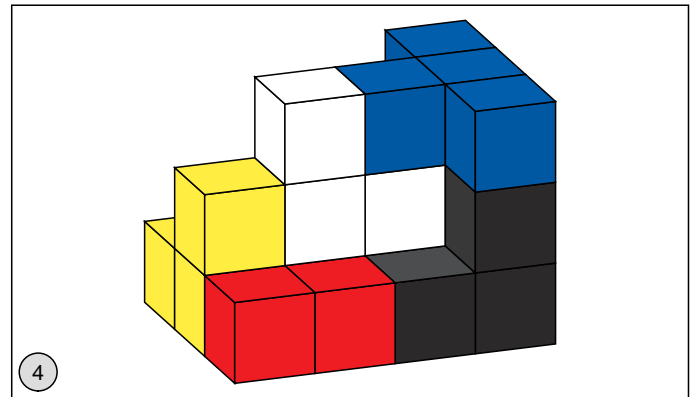
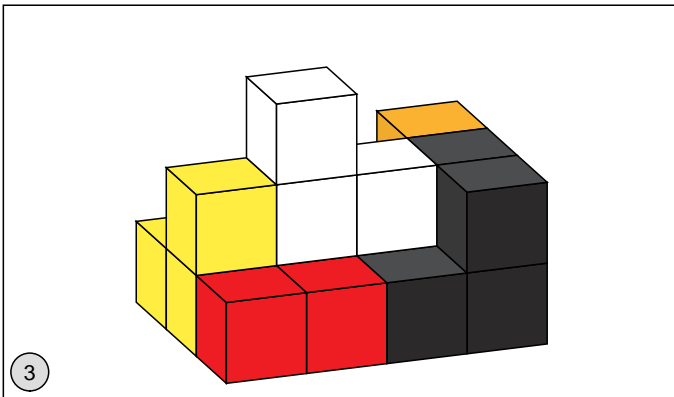
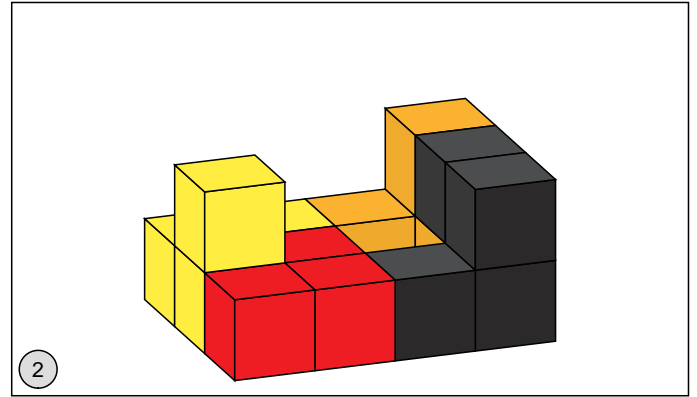
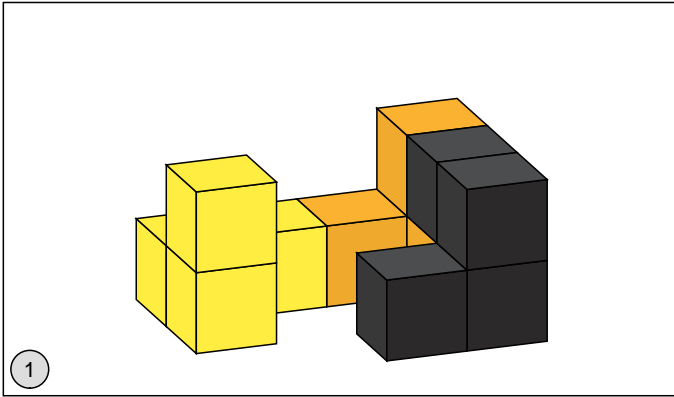

Soma-Baupläne

12

Aufgabe: Baue die Figur aus allen sieben Somateilen nach dem Bauplan.

1	2	3	2	1
1	2	2	2	1
1	1	1	1	1
1	1	1	1	1



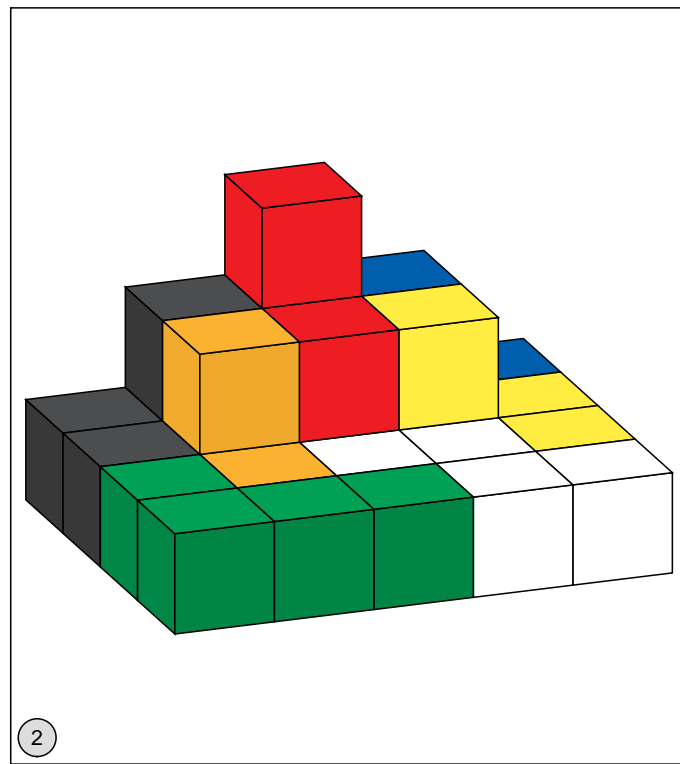
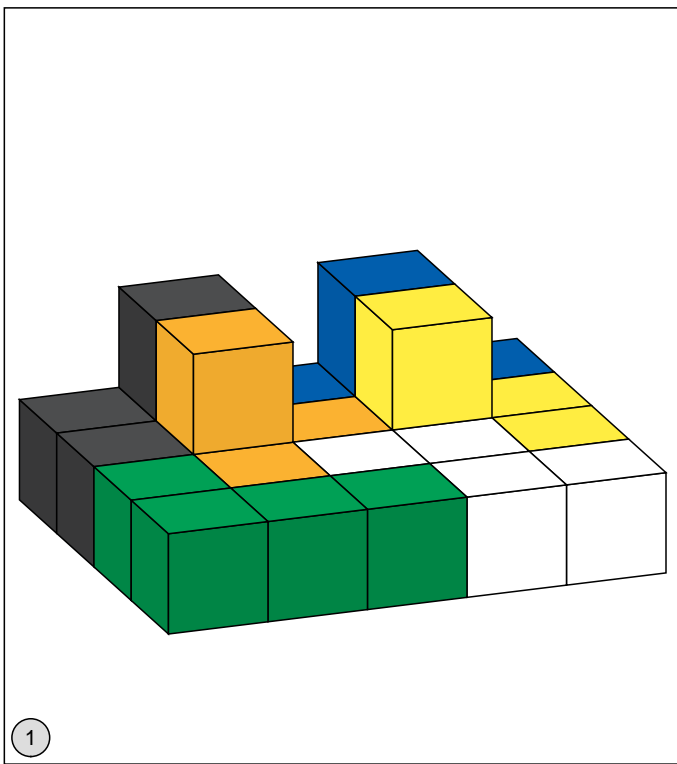

Soma-Baupläne

13

Aufgabe: Baue die Figur aus allen sieben Somateilen nach dem Bauplan.

2	2	1	2	2
2	2	1	2	1
1	1	1		
2	2			
2	1			



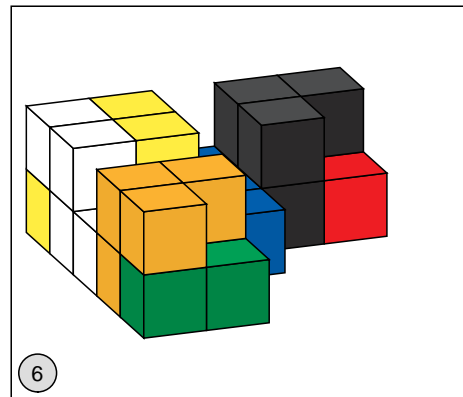
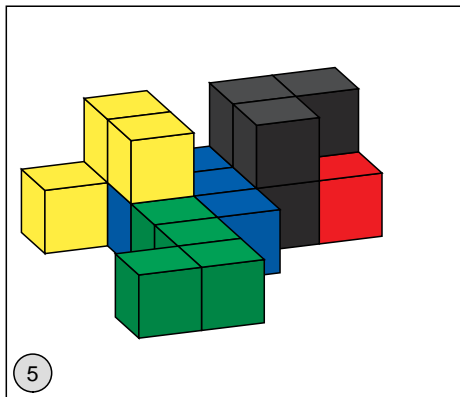
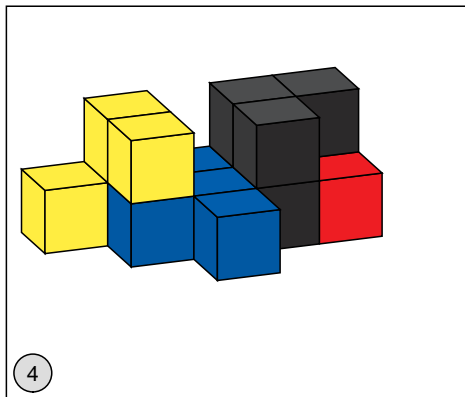
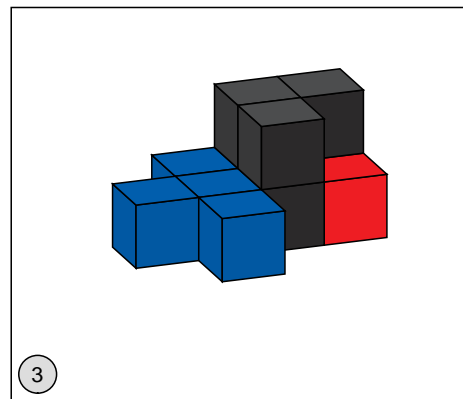
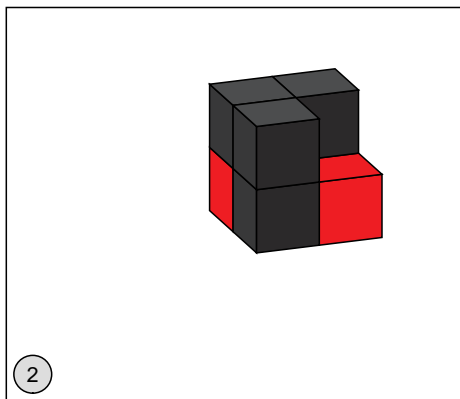
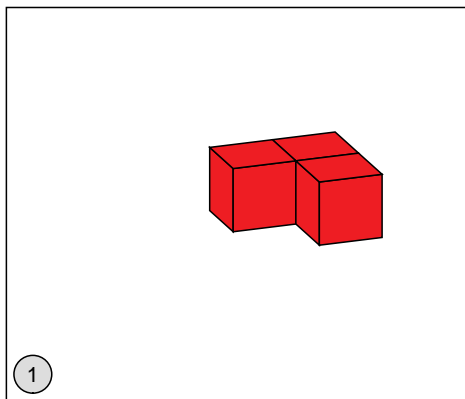

Soma-Baupläne

14

Aufgabe: Baue die Figur aus allen sieben Somateilen nach dem Bauplan.

1	2	2	2	2
2		1		1
2	1	1	1	1
2		1	1	
2	1	1		



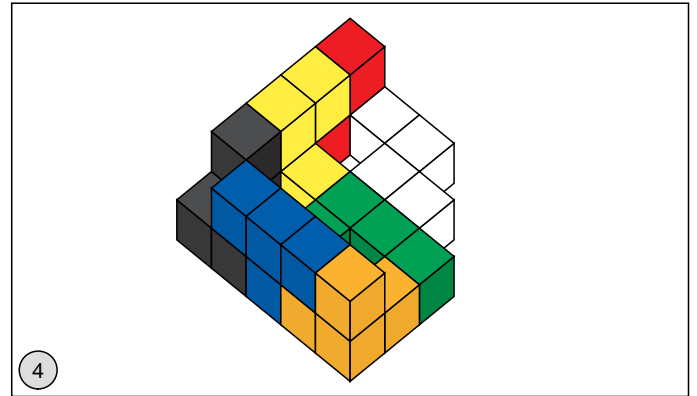
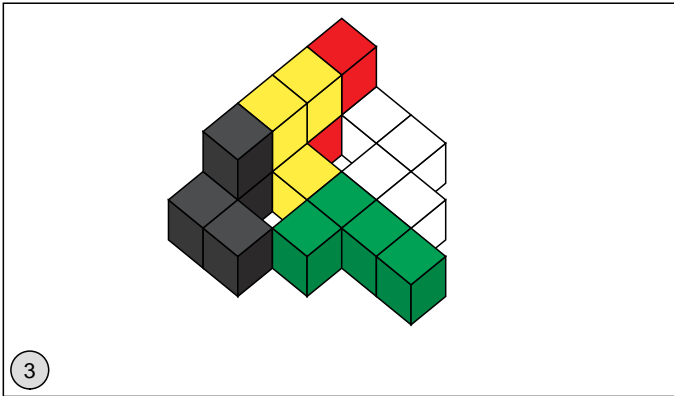
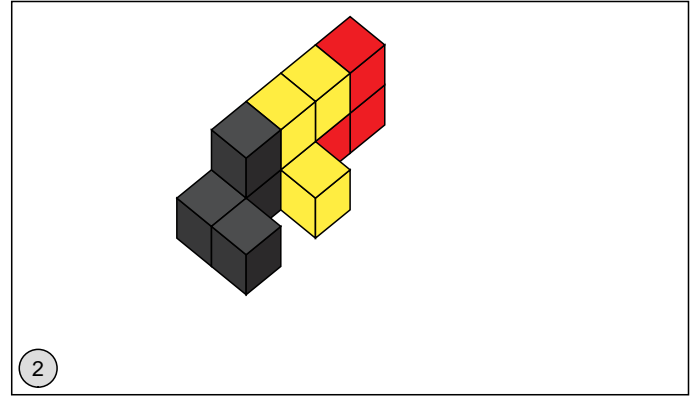
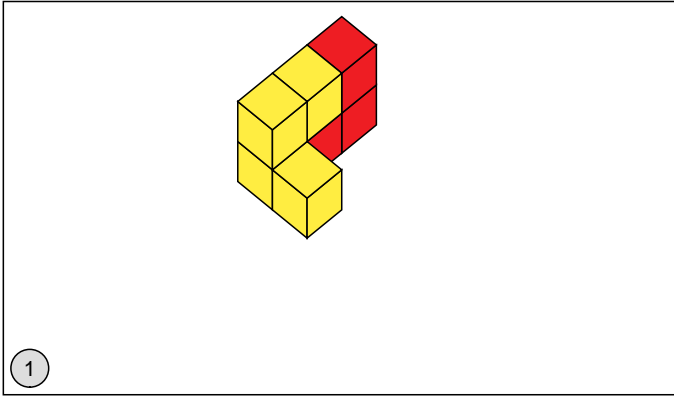

Soma-Baupläne

15

Aufgabe: Baue die Figur aus allen sieben Somateilen nach dem Bauplan.

2	1	1	1	2
2	3	3	3	2
2	1	1	1	2



Lösung

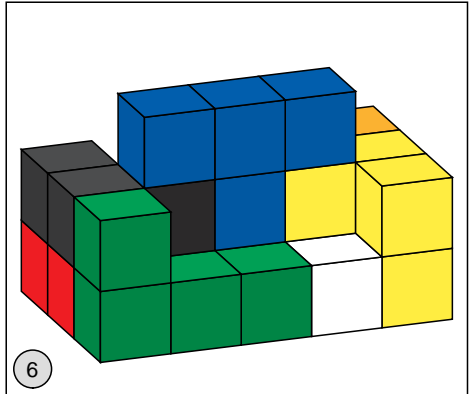
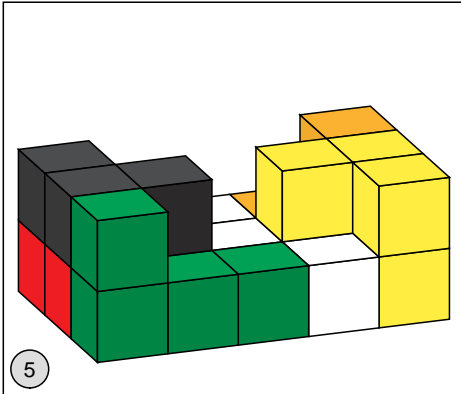
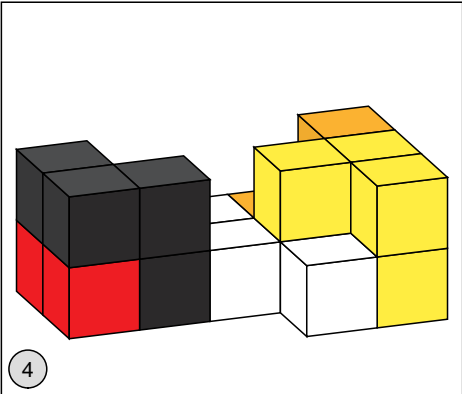
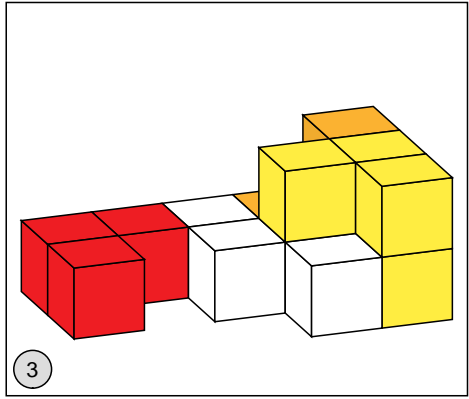
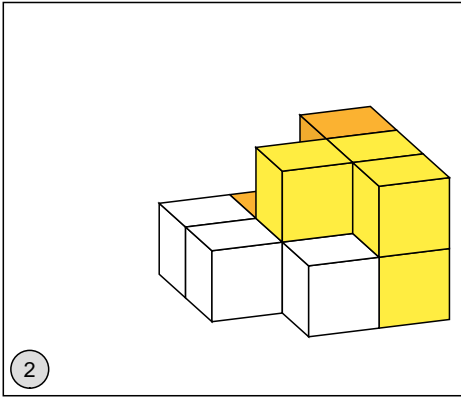
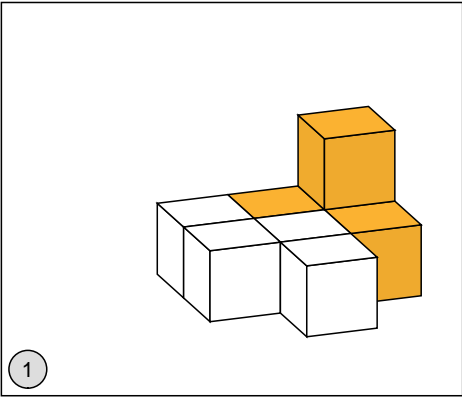

Soma-Baupläne

16

Aufgabe: Baue die Figur aus allen sieben Somateilen nach dem Bauplan.

4	1	1	1
4	4	3	2
4	1	1	1



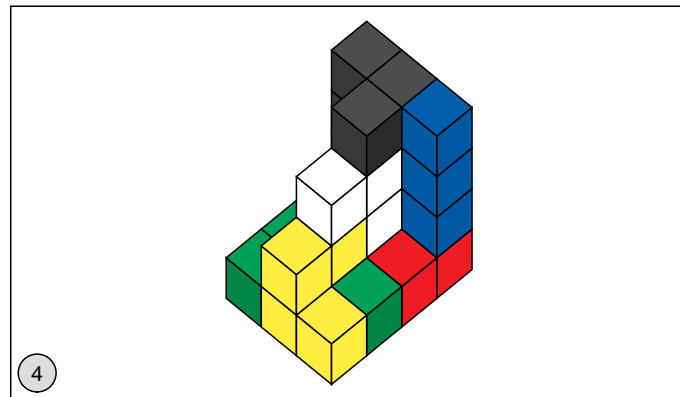
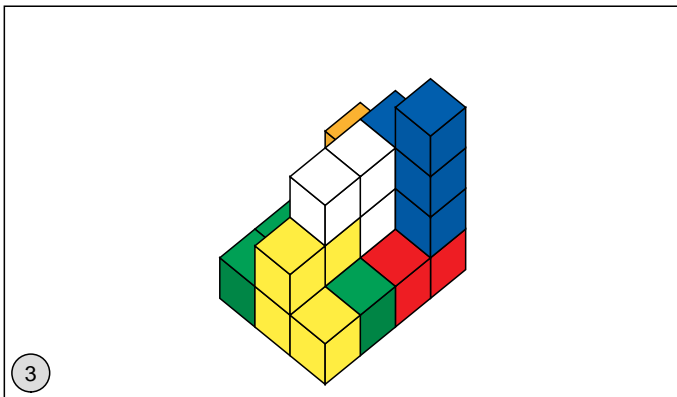
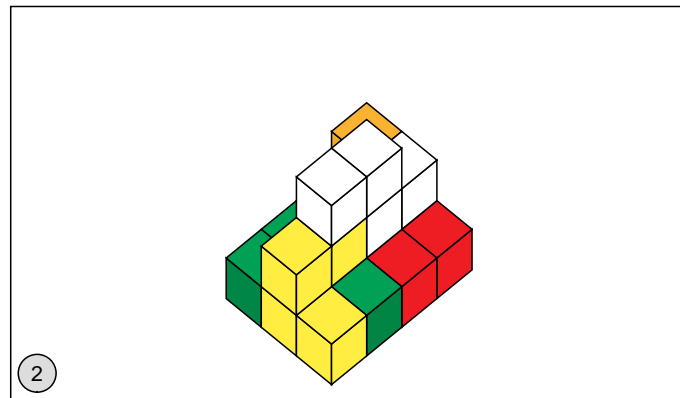
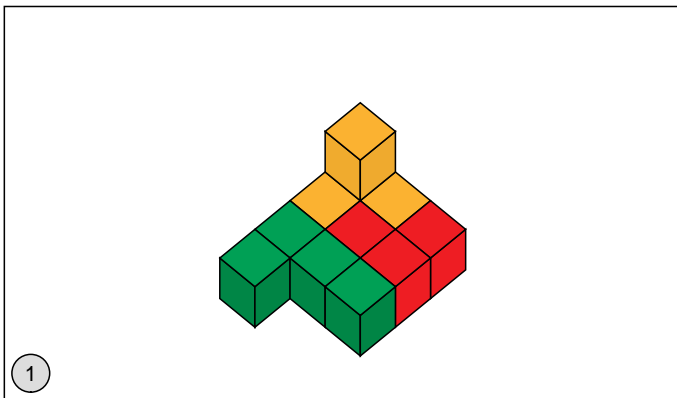



Soma-Baupläne

Aufgabe: Baue die Figur aus vier Somateilen nach dem Bauplan.

2	2	2
1	2	2
1	1	2



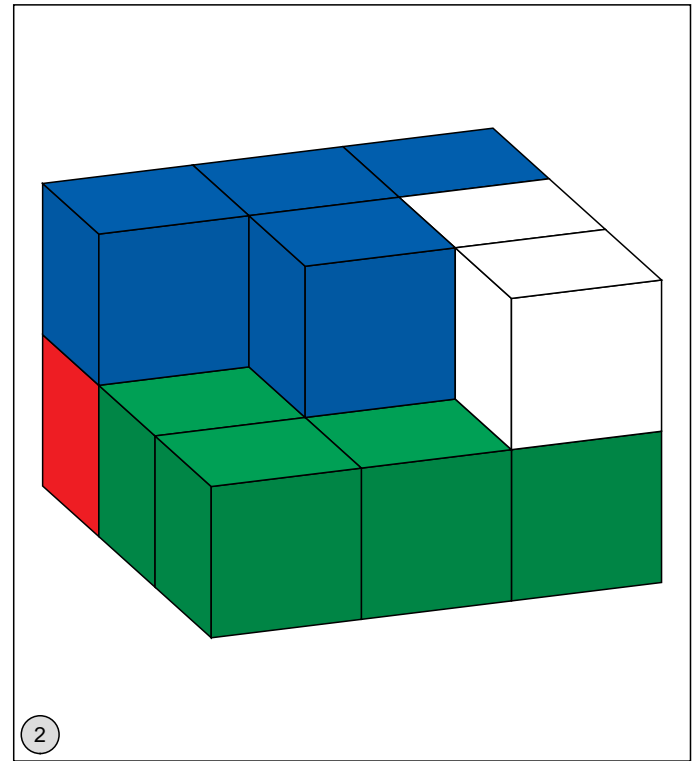
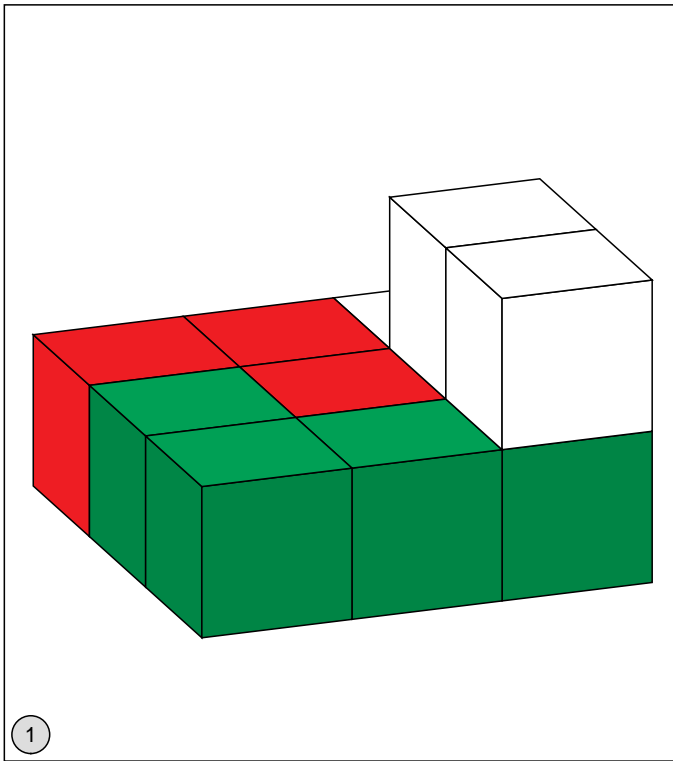



Soma-Baupläne

Aufgabe: Baue die Figur aus vier Somateilen nach dem Bauplan.

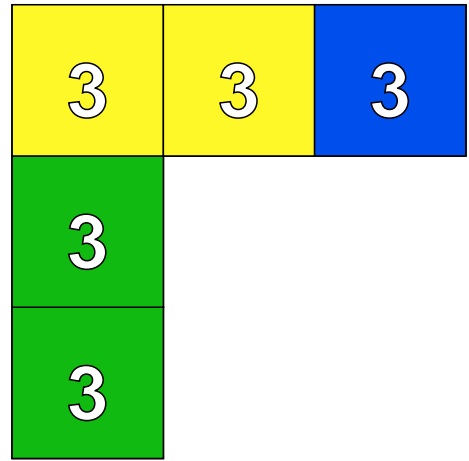

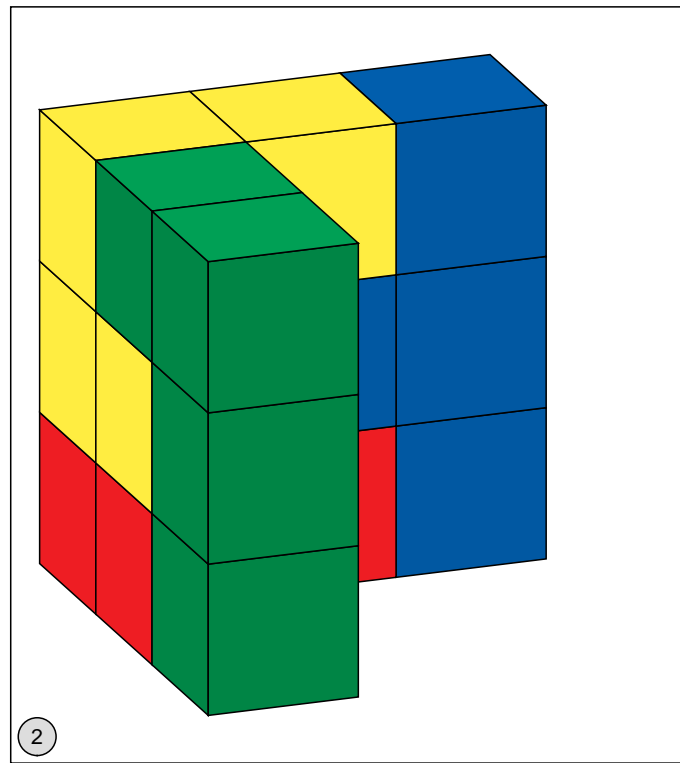
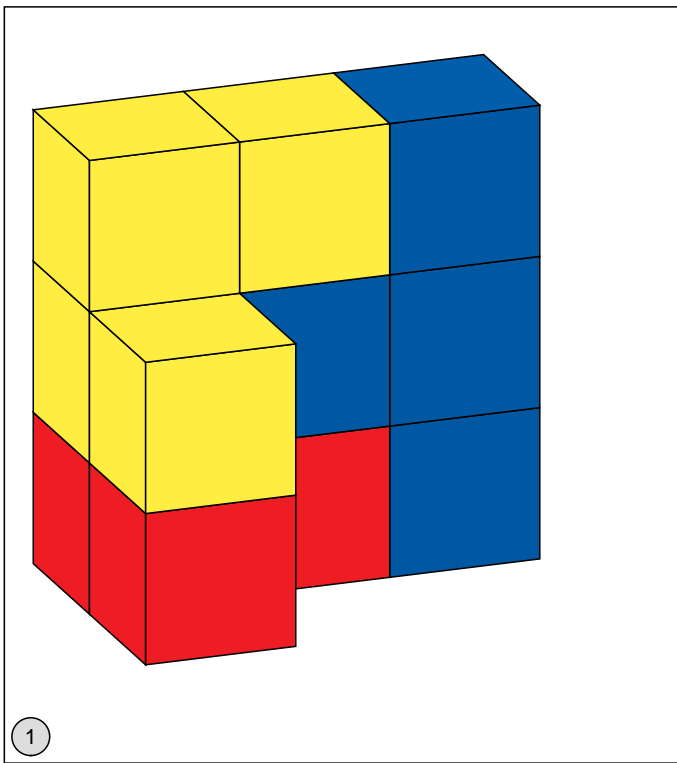



Soma-Baupläne

Aufgabe: Baue die Figur aus fünf Somateilen nach dem Bauplan.

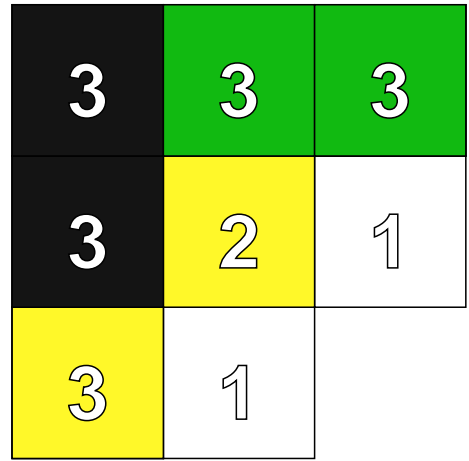

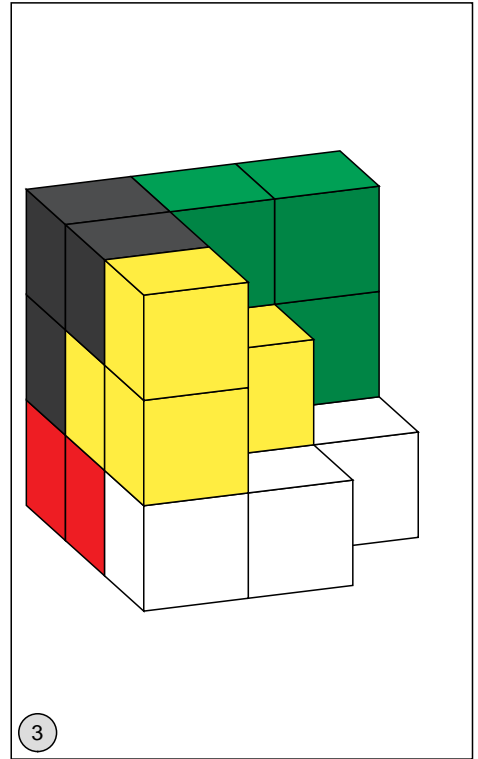
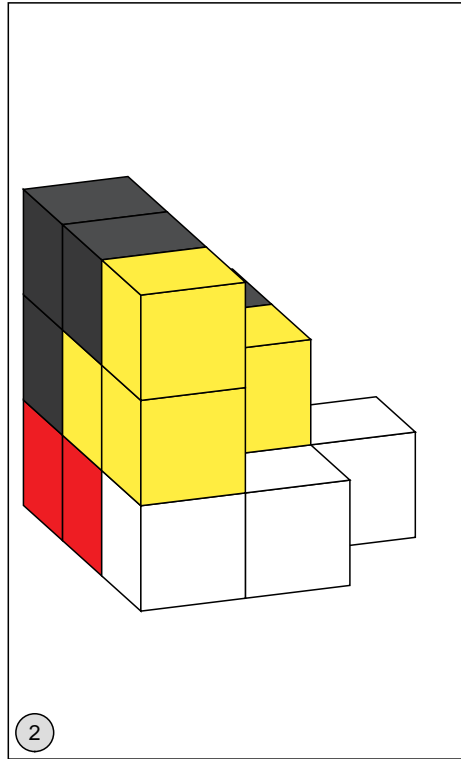
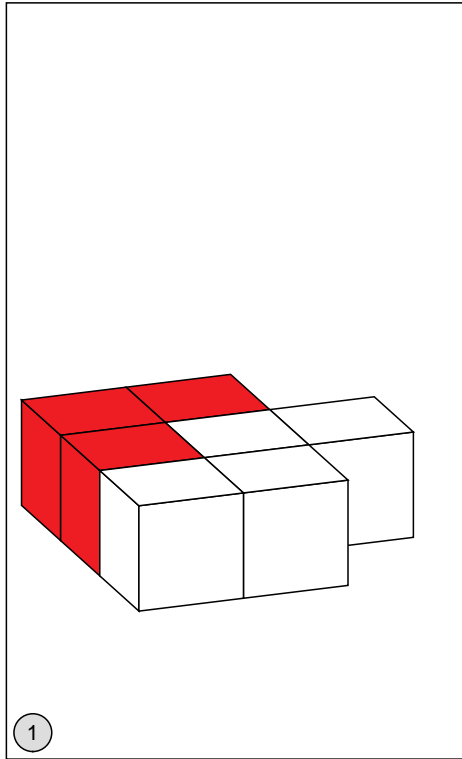



Soma-Baupläne

Aufgabe: Baue die Figur aus fünf Somateilen nach dem Bauplan.

2	3	2
2	3	2
1	2	2



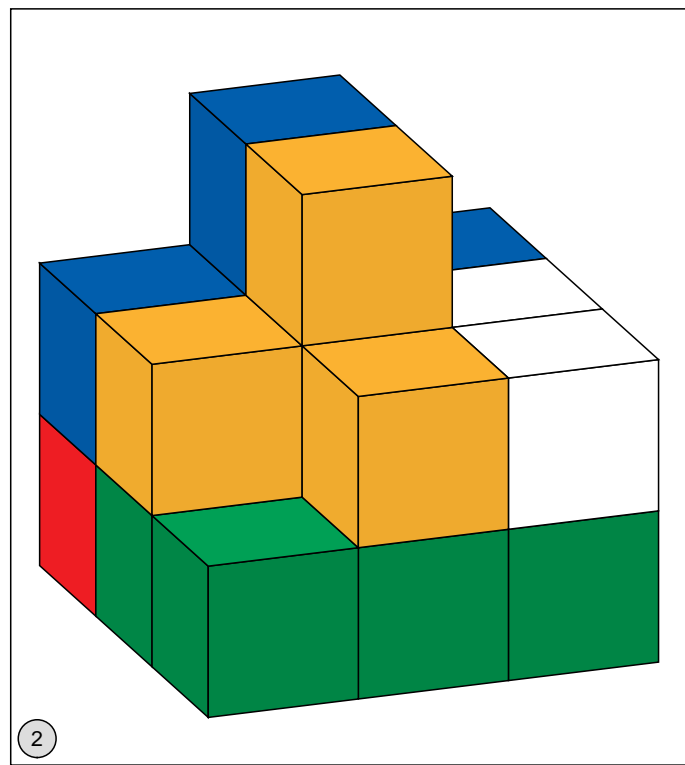
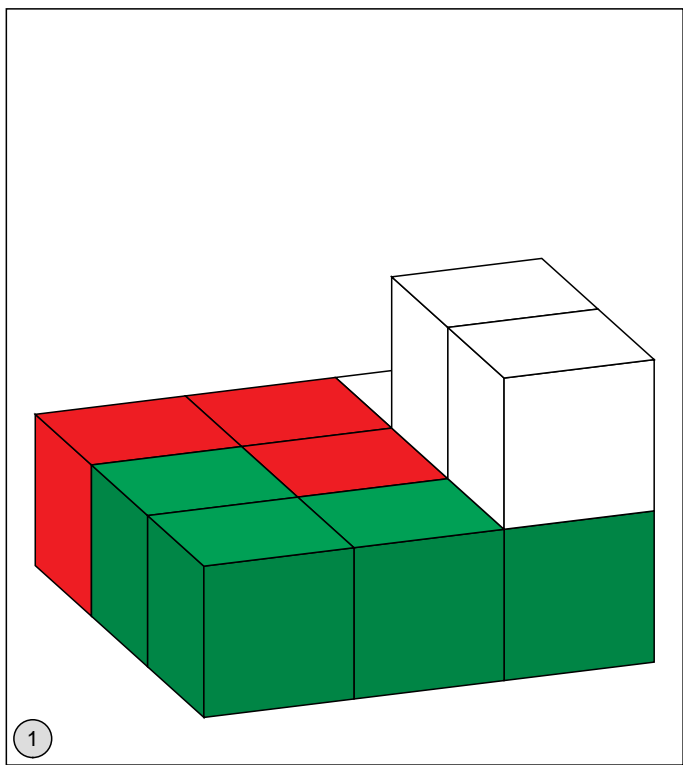



Soma-Baupläne

Aufgabe: Baue die Figur aus sechs Somateilen nach dem Bauplan.

2	3	2
3	3	3
2	4	1



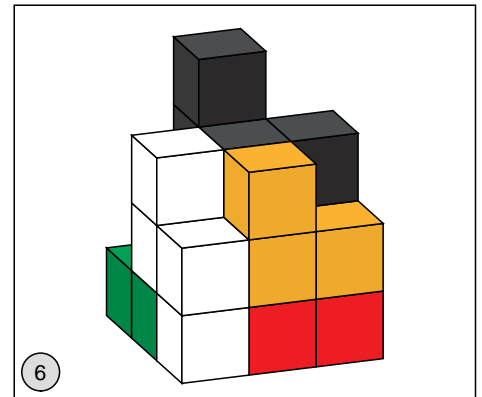
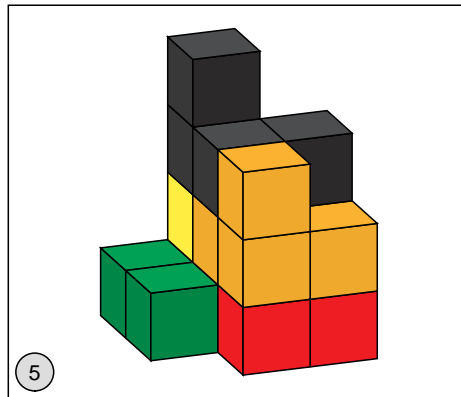
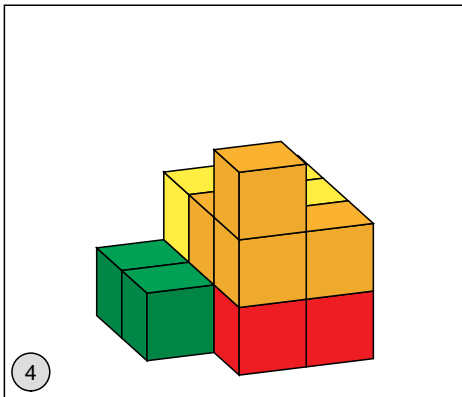
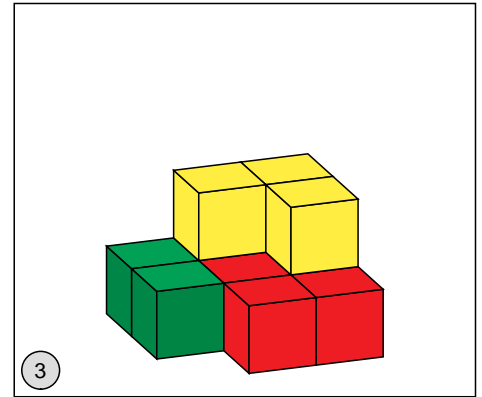
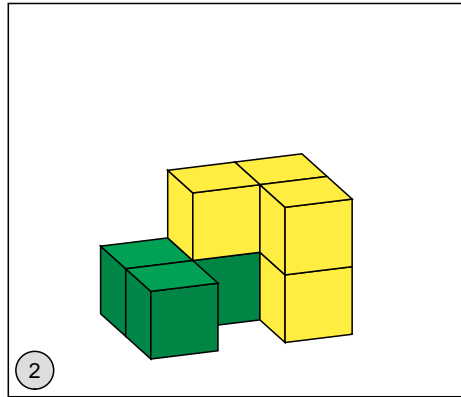
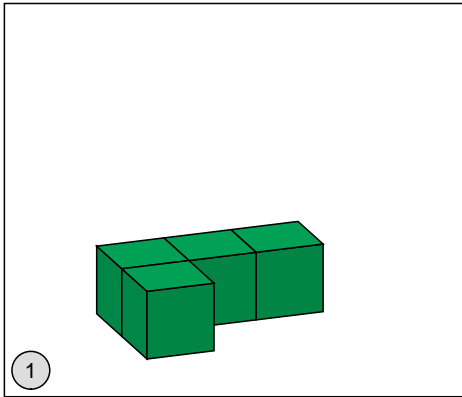



Soma-Baupläne

Aufgabe: Baue die Figur aus sechs Somateilen nach dem Bauplan.

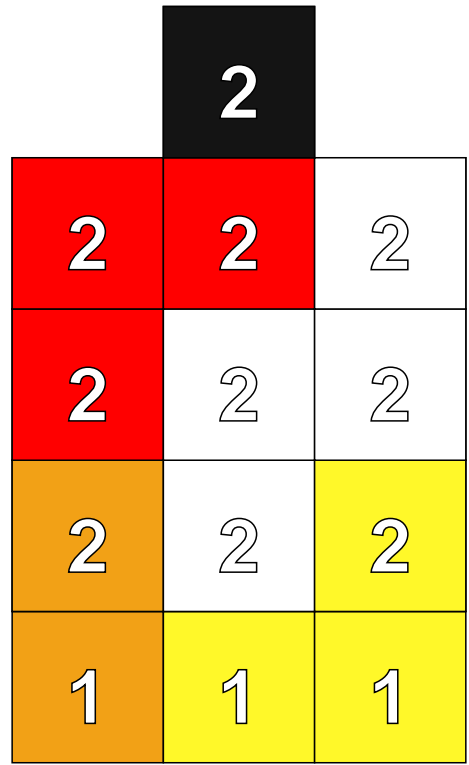

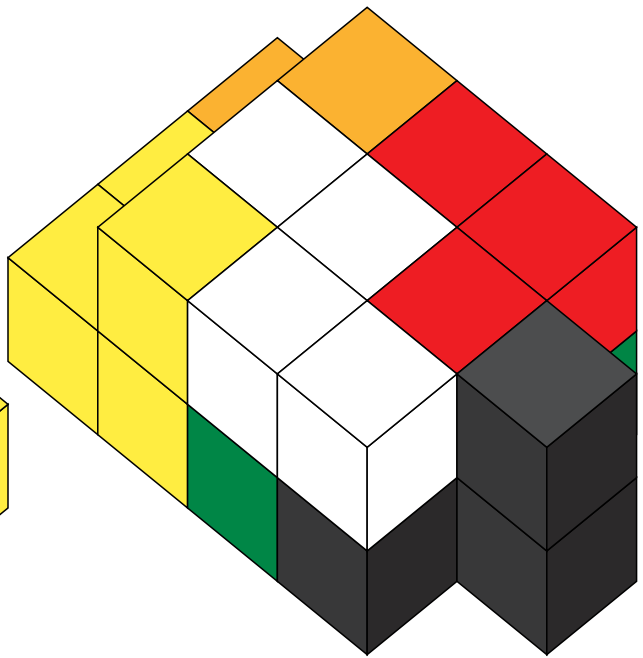
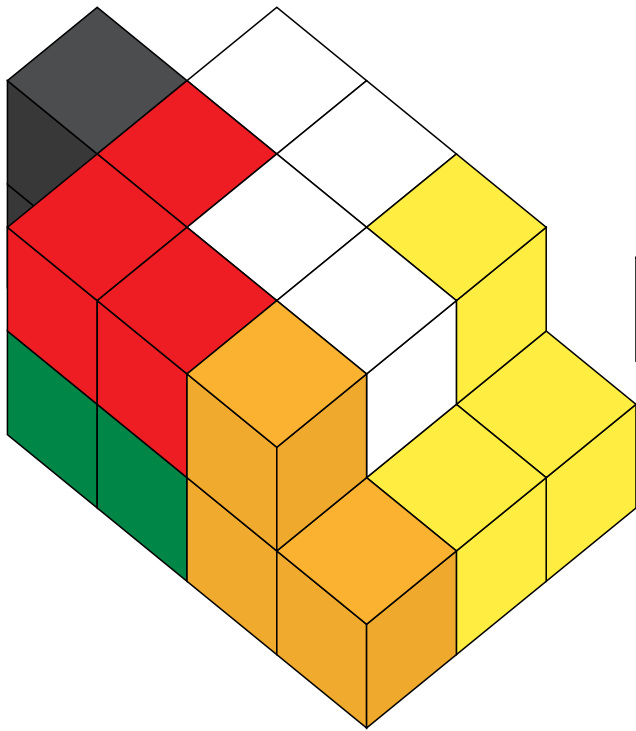

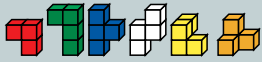

Soma-Baupläne

Aufgabe: Baue die Figur aus sechs Somateilen nach dem Bauplan.

3	3	3
2	2	3
3	2	2



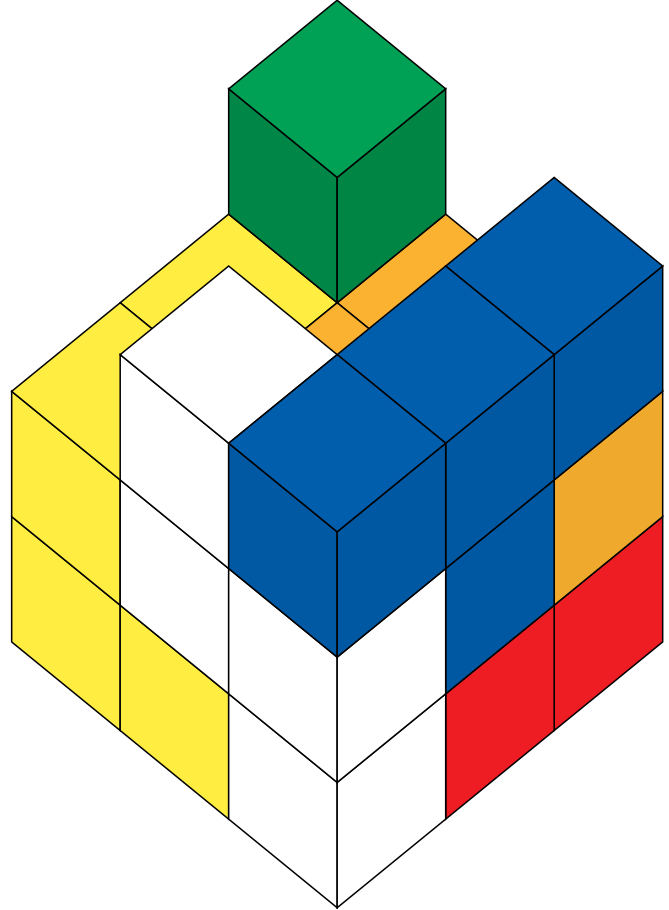
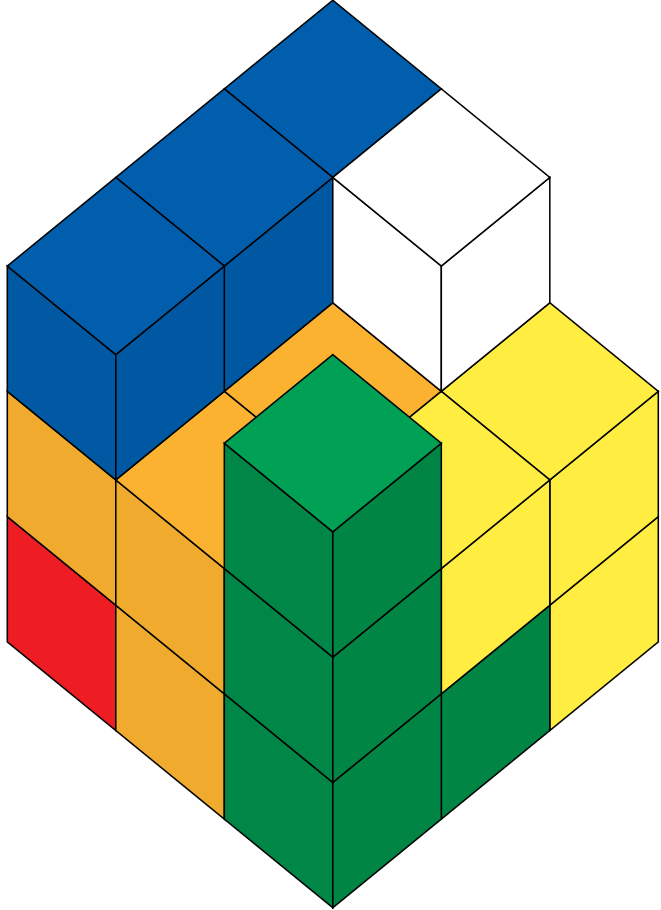

Soma-Baupläne

24

Aufgabe: Baue die Figur aus allen sieben Somateilen nach dem Bauplan.

2	2	2	2	2
2	1	1	1	2
2	2	2	2	2



Lösung

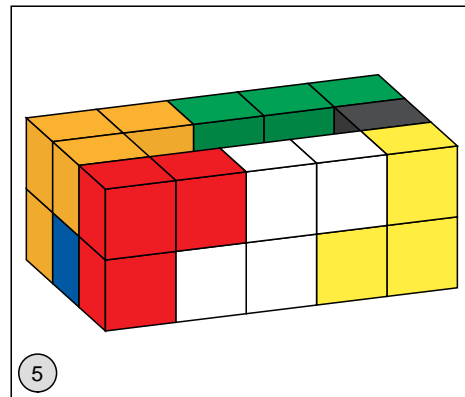
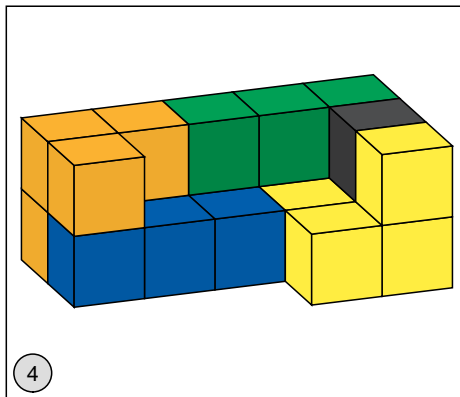
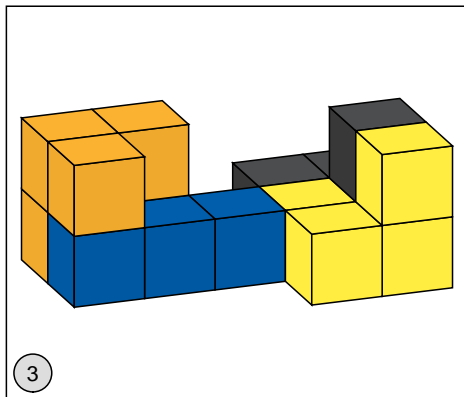
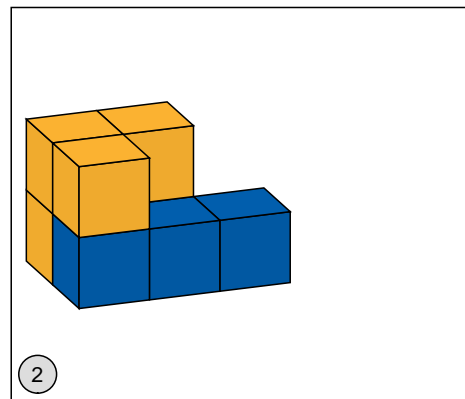
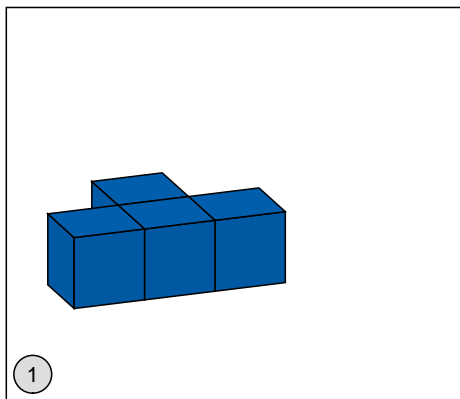
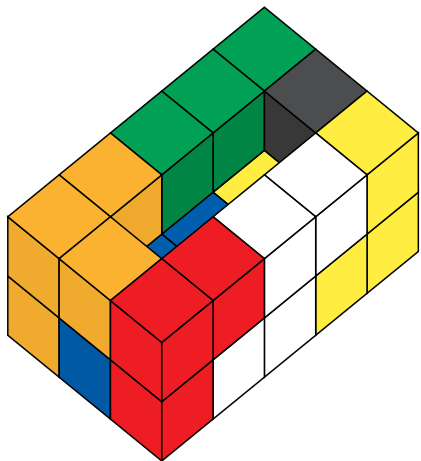

Soma-Baupläne

25

Aufgabe: Baue die Figur aus allen sieben Somateilen nach dem Bauplan.

3	3	3	3	3
2	1	1	1	2
1	1	1	1	1



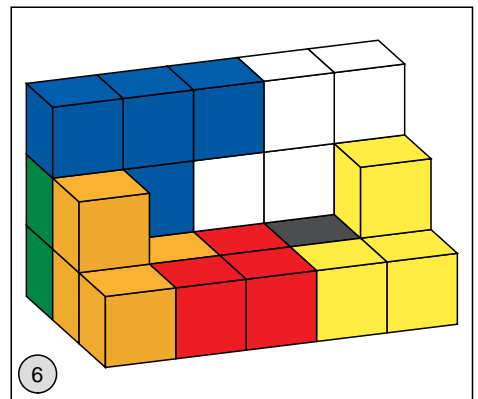
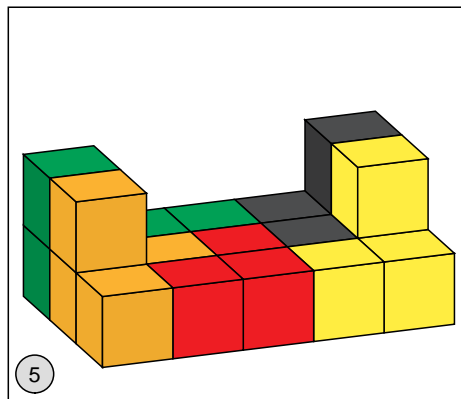
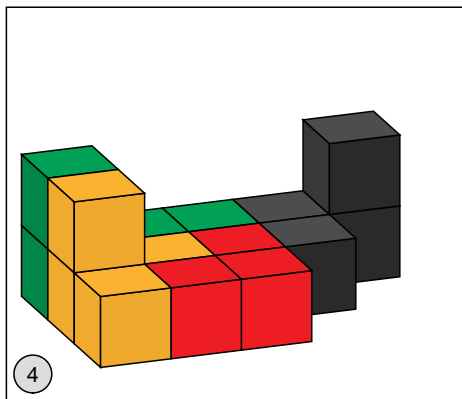
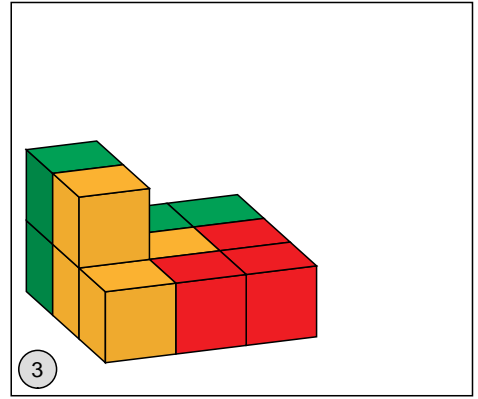
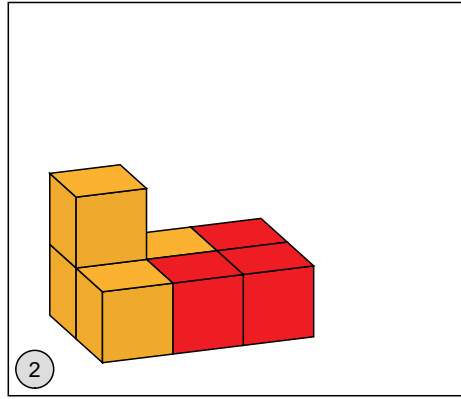
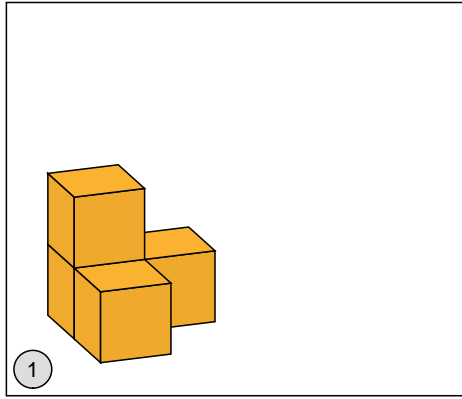

Soma-Baupläne

26

Aufgabe: Baue die Figur aus allen sieben Somateilen nach dem Bauplan.

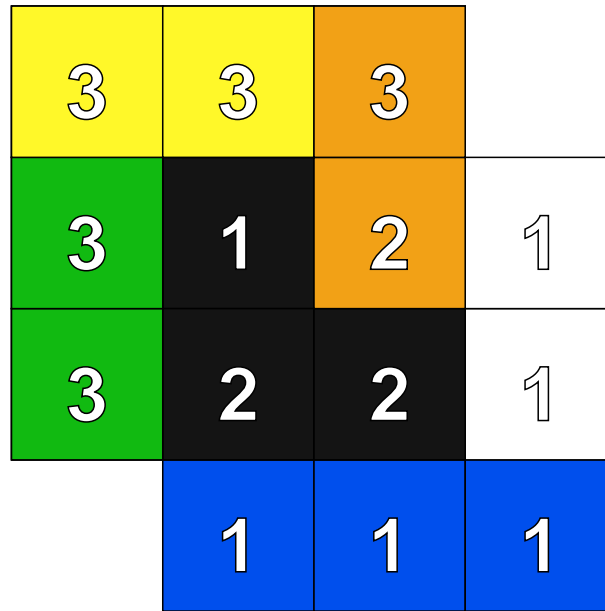

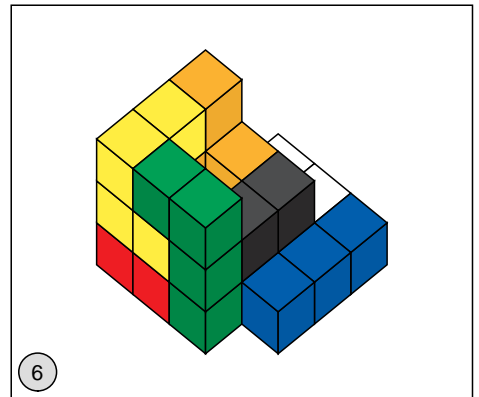
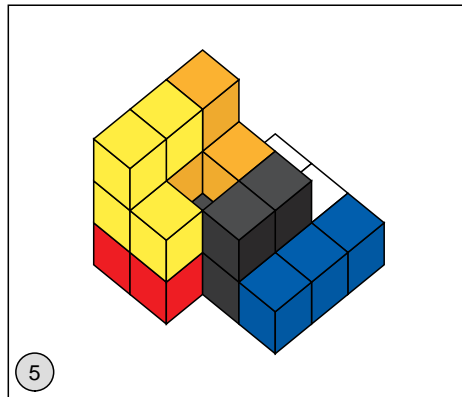
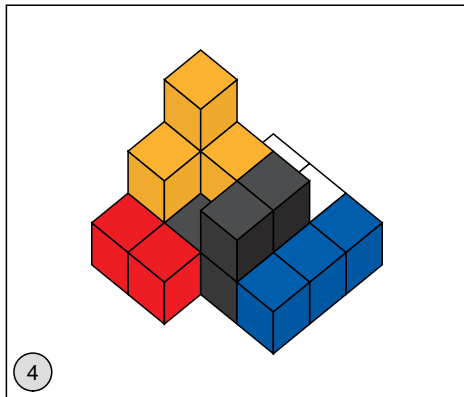
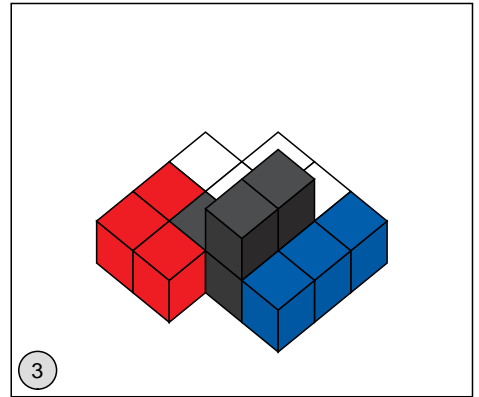
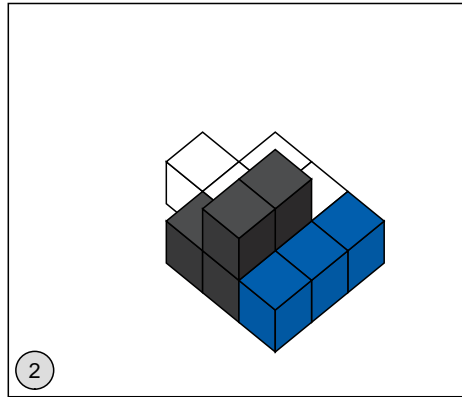
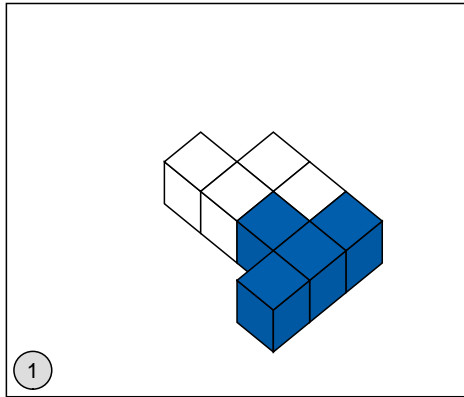

Soma-Baupläne

27

Aufgabe: Baue die Figur aus allen sieben Somateilen nach dem Bauplan.

2	2	2
2	1	2
1	2	2
1	2	1
1	1	1
1	2	1



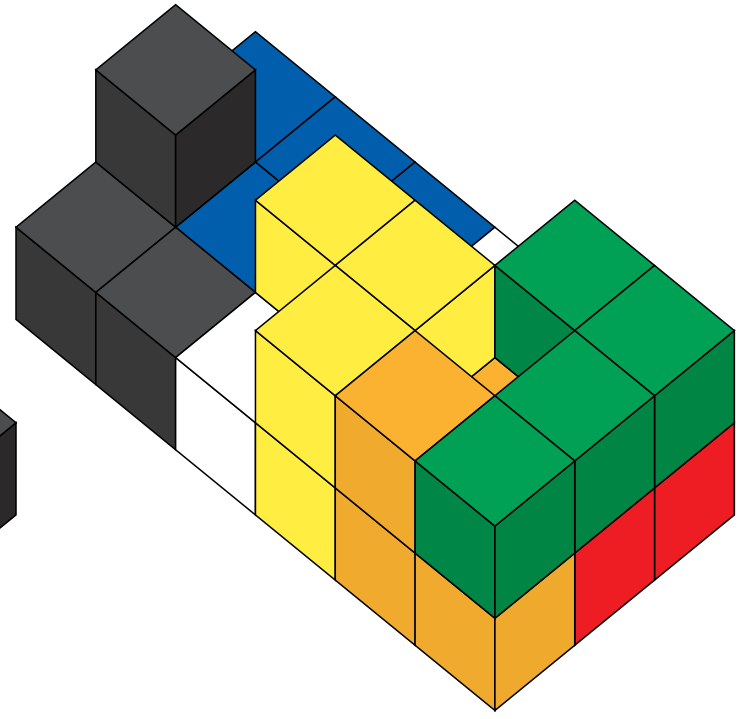
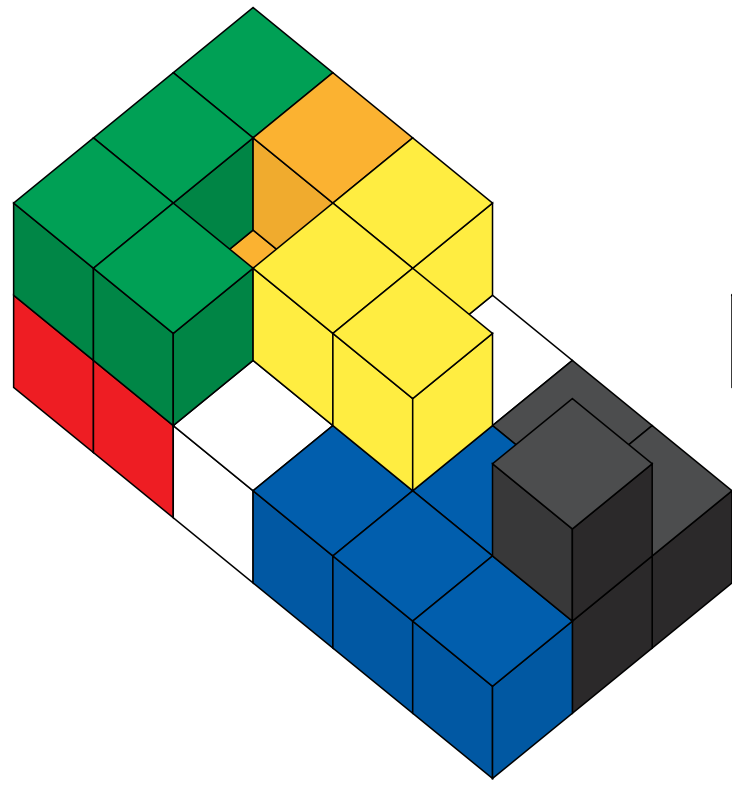



Soma-Baupläne

Aufgabe: Baue die Figur aus fünf Somateilen nach dem Bauplan.

2	2	2
2	3	2
2	2	2



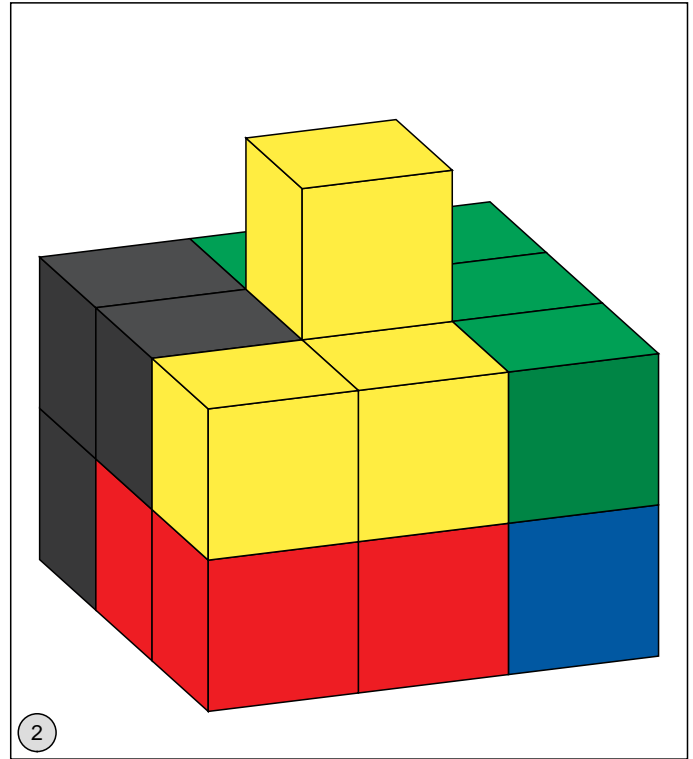
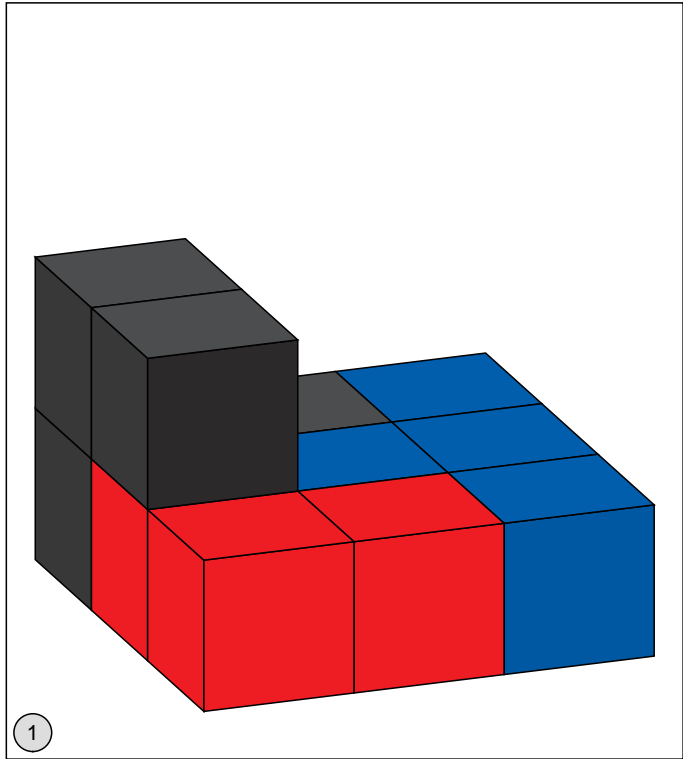

Soma-Baupläne

29

Aufgabe: Baue die Figur aus allen sieben Somateilen nach dem Bauplan.

4	4	3
4	4	2
3	2	1



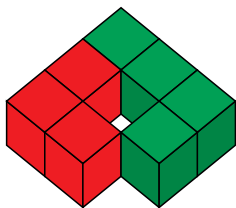

1

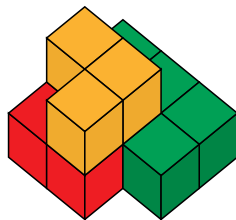

2

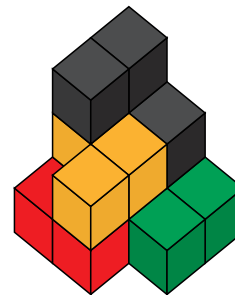

3

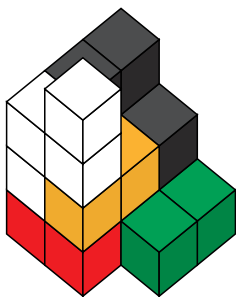

4

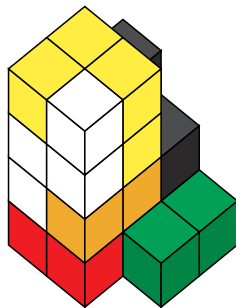

5

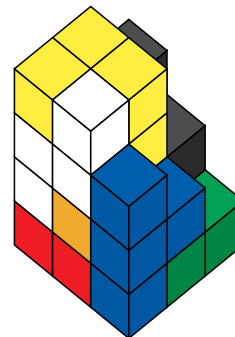

6

Soma-Baupläne

30

Aufgabe: Baue die Figur aus allen sieben Somateilen nach dem Bauplan.

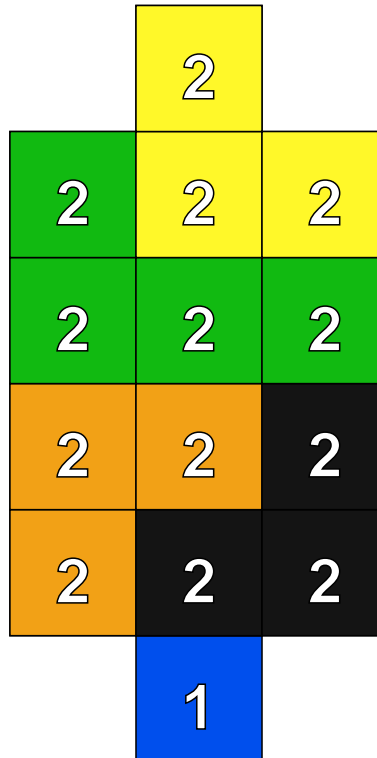

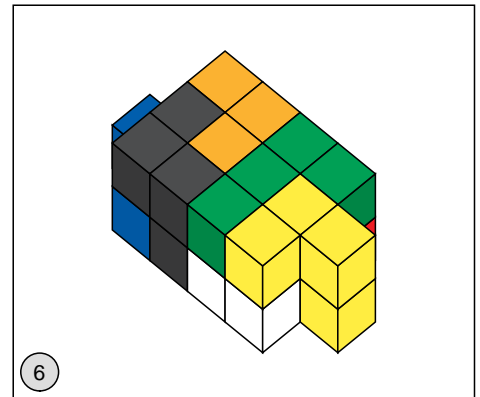
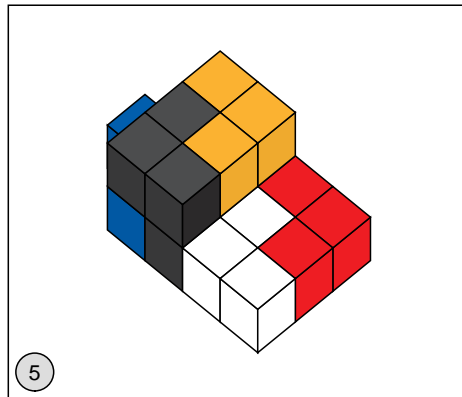
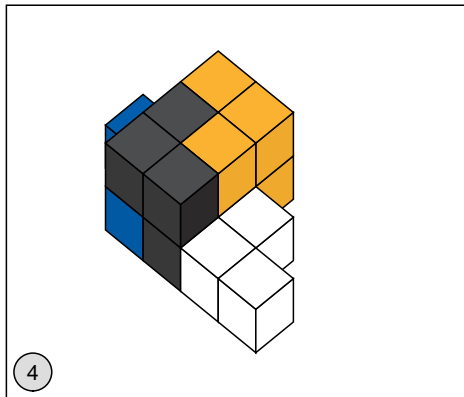
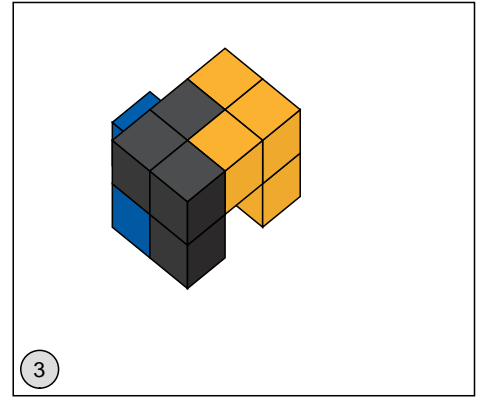
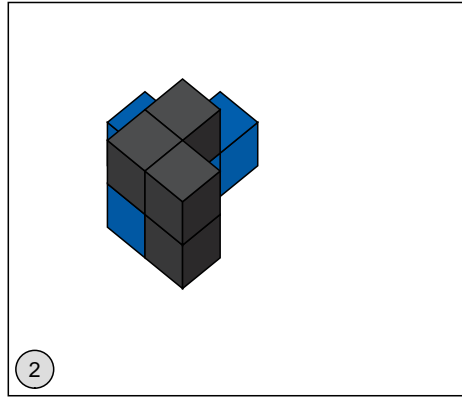
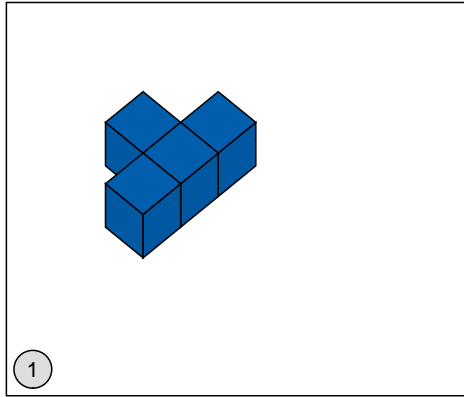

Soma-Baupläne

Aufgabe: Baue die Figur aus allen sieben Somateilen nach dem Bauplan.

